

TOP DEAL

KSTOOLS

WWW.KSTOOLS.COM

No Limits!

UNSERE SCHLÜSSELKOMPETENZ:

QUALITÄT ZUM HAMMER-PREIS!

EVOLUTION
SERIES



Komplette
Stückliste

917.0255

1/4" + 3/8" + 1/2" + 5/16"

255 TEILE
FÜR NUR

180,00

i  **397**
Weitere Informationen

P₁₀

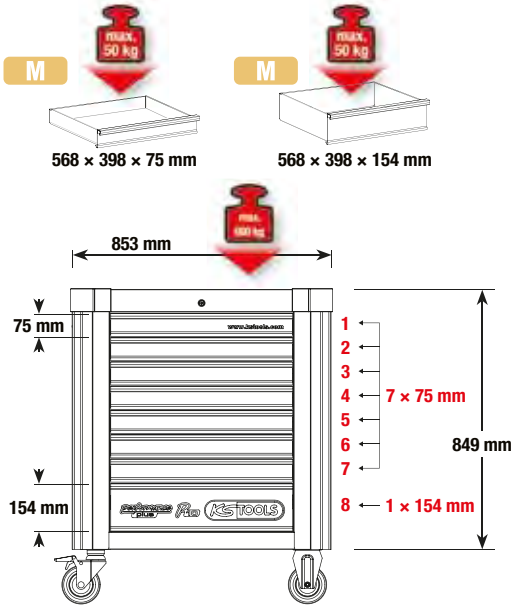

WÄHLEN SIE IHR POWER-PAKET

810.7397

i  **397**
Weitere Informationen

Options for the power package:

- inklusive Papierrollenhalter
- inklusive Dosenhalter
- Stabile Kugellager
- Antistatische Rollen mit Bremse

815.7397

P₁₅

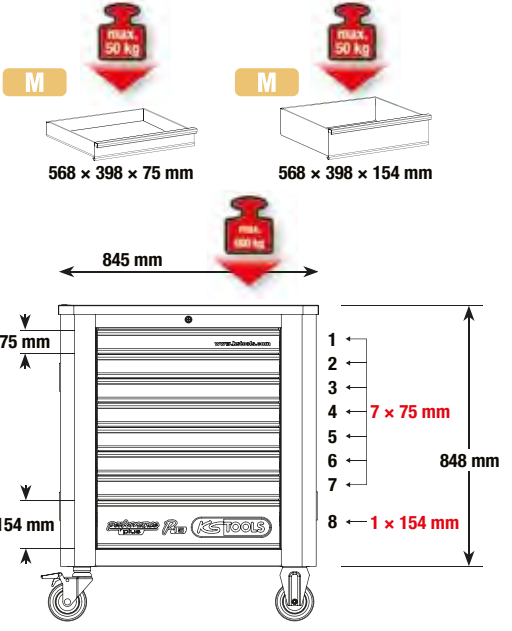

DAS PERFEKTE PAKET MIT 397 TEILEN

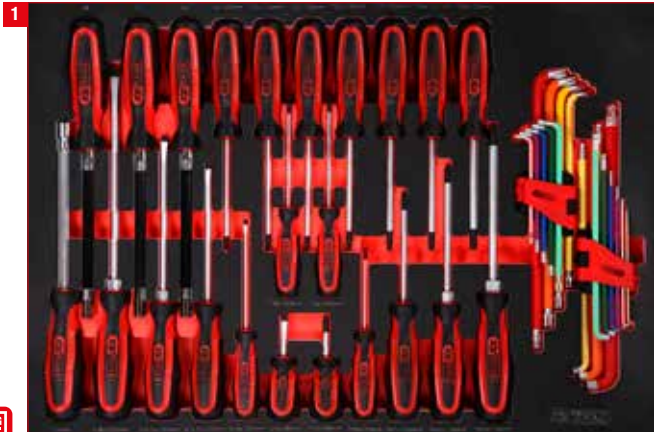

41 Schraubendreher-Satz



41 Schraubenschlüssel-Satz

4049,00

810.7397 P10 Werkstattwagen mit 397 Werkzeugen



111 1/4" + 3/8" + 1/2" Steckschlüssel-Satz

4199,00

815.7397 P15 Werkstattwagen mit 397 Werkzeugen



28 Zangen- und Feilen-Satz



43 Öl- und Reifendienst-Satz



111 1/2" Bit-Stecknuss-Satz



22 Hammer- und Meißel-Satz

HERZLICH WILLKOMMEN IN

i **564**
 Weitere Informationen



MIT 564 WERKZEUGEN

5699,00



Integrierter Kantenschutz



inklusive Dosenhalter



Stabile Kugellager



Antistatische Rollen mit Bremse



Schloss

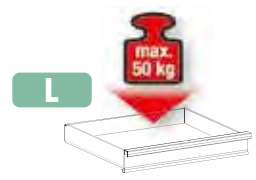
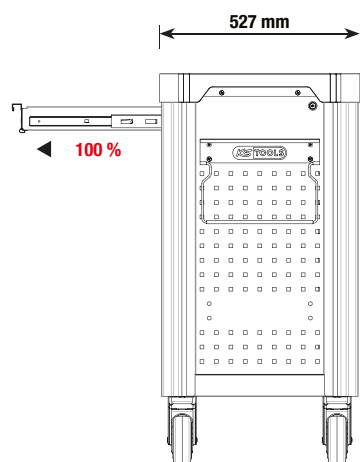
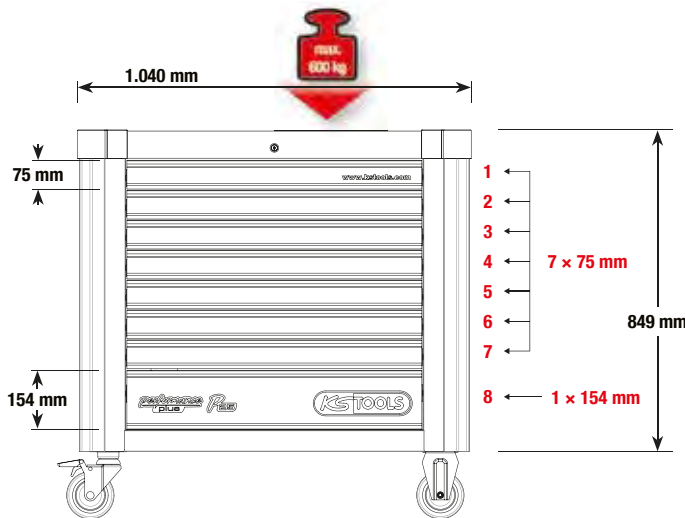

755 × 398 × 75 mm

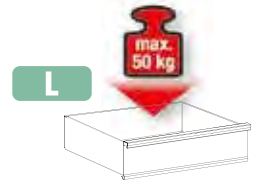

755 × 398 × 154 mm

825.8564

DER KÖNIGSKLASSE!

Performance
plus

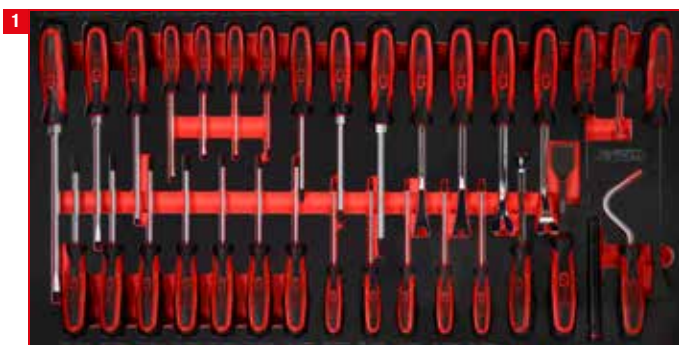

Schraubendreher-Satz

33



1/4" + 3/8" Steckschlüssel-Satz

213



1/2" Steckschlüssel-Satz

86

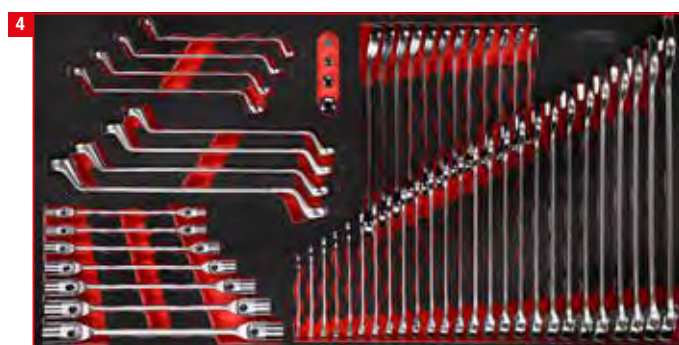

Schraubenschlüssel-Satz

57



Schraubenschlüssel-Satz

54

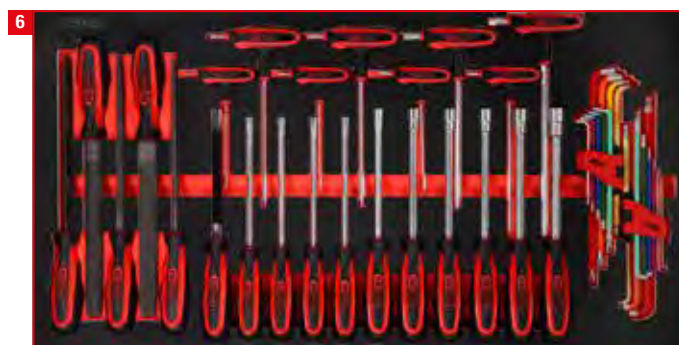

Schraubendreher- und Feilen-Satz

42

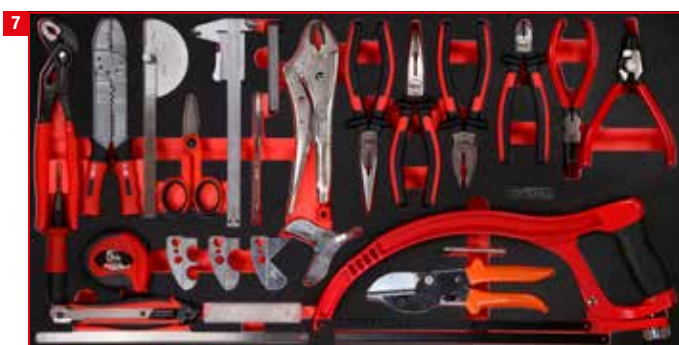

Zangen- und Messwerkzeug-Satz

39



Hammer- Meißel- und Kraft-Stecknuss-Satz

40

WIE VIEL WAGEN DARF'S SEIN?



Arbeitsplatte mit 10 mm starker Schaumstoffeinlage



verschiebbar durch eingebautes Zylinderschloss



mit Selbsteinzug und SOFT-CLOSE-Funktion



Vierkantlochung für Zubehörteile



2 x Roll- und Drehbremsen Ø Räder: 125 mm

ECO Line

675,00

OHNE WERKZEUGE



max. 300 kg

max. 25 kg

ECO Line

KSTOOLS

i **1** 897.0007
Weitere Informationen

Technische Daten:	Eco Line 897.0007	Racing Line 826.0007
Gesamttragkraft:	300,0 kg	350,0 kg
Belastbarkeit je Schublade:	25,0 kg	30,0 kg
Selbsteinzug und SOFT-CLOSE-Funktion:	✓	✗
Raddurchmesser:	125,0 mm	125,0 mm
Radfeststeller:	✓	✓
Mit Zentralverriegelung:	✓	✓
Einzelverriegelung Schubladen:	✗	✓
Höhe:	1014,0 mm	976,0 mm
Breite:	748 mm	788 mm
Tiefe:	459,0 mm	496,0 mm
Schubladeninnenmaß:	565 x 395 mm	565 x 395 mm
mit Polyurethan Ecken-Kantenschutz:	✗	✓
Vierkantlochung für Zubehörteile:	✓	✓
Anzahl Schubladen:	7	7
Blechstärke:	0,8 mm	0,9 mm
Griffeisten:	✓	✓
Schubladenauszug:	100 %	90 %
Arbeitsplatte mit Kleinteilfächern:	✗	✓
Arbeitsplatte mit Schaumstoffeinlagen:	✓	✗
kugellagerte Schubladenföhrung:	✓	✓
seitlicher Metallhandgriff:	✓	✓

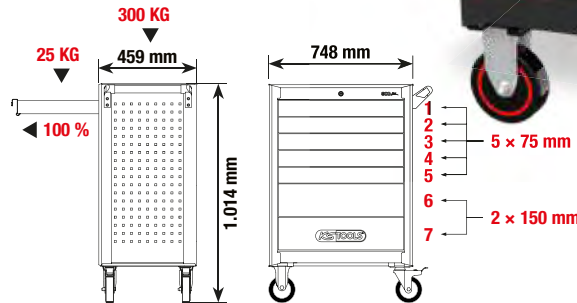

QUAL DER WAHL? WAHL MIT QUALITÄT!

RACING Line



Arbeitsplatte aus ABS mit Kleinteilfächern



verschiebbar durch eingebautes Zylinderschloss



Einzelverriegelung verhindert ungewolltes Öffnen



Vierkantlochung für Zubehörteile



2 x Roll- und Drehbremsen Ø Räder: 125 mm

750,00

OHNE WERKZEUGE



max. 350 kg

max. 30 kg

RACING Line

KSTOOLS

i **1** 826.0007
Weitere Informationen

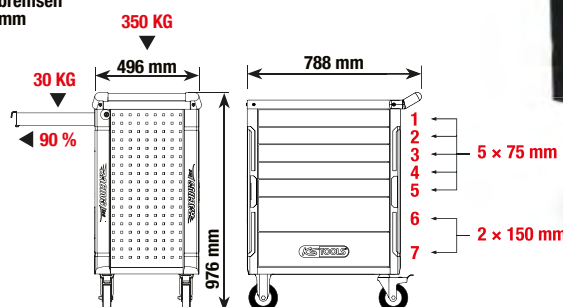

ECO *line*

Mit 7 Schubladen und
215 Premium-Werkzeugen

1020,00

897.7215

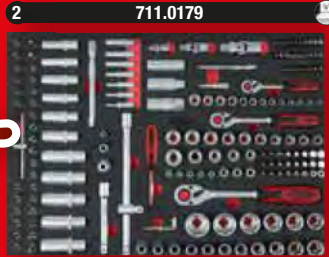

START PAKET - 215 TLG.

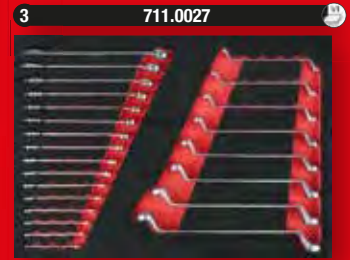

215
Weitere Informationen

RACING *line*

Mit 7 Schubladen und
215 Premium-Werkzeugen

1050,00

826.7215

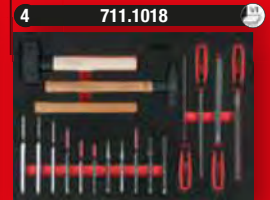
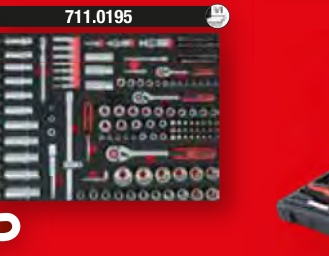
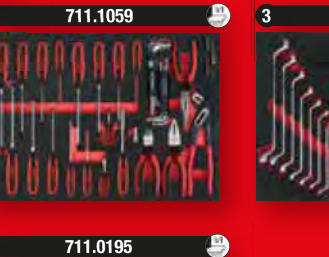

UNIVERSAL PAKET - 515 TLG.

515
Weitere Informationen

ECO *line*

Mit 7 Schubladen und
515 Premium-Werkzeugen

1320,00

897.7515



RACING *line*

Mit 7 Schubladen und
515 Premium-Werkzeugen

1350,00

826.7515



ECO *line*

Mit 7 Schubladen und
598 Premium-Werkzeugen

1949,00

897.7598

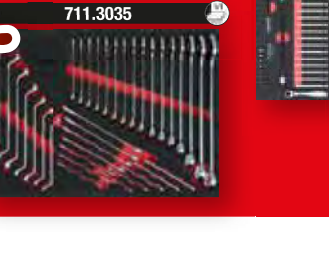
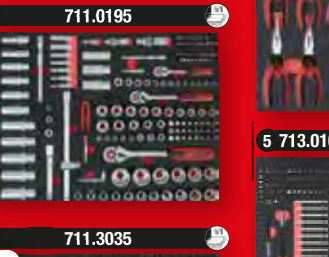
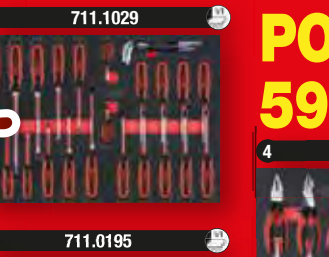

POWER PAKET - 598 TLG.

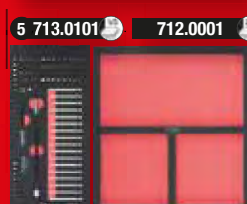
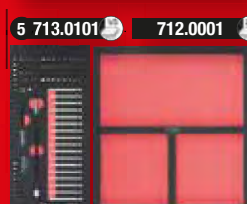

598
Weitere Informationen

RACING *line*

Mit 7 Schubladen und
598 Premium-Werkzeugen

2024,00

826.7598



- DIN 3110 / ISO 1085 / ISO 10102 / ISO 3318
- Maulstellung 15° abgewinkelt
- geschliffene Köpfe
- matt satiniert
- Chrom Vanadium

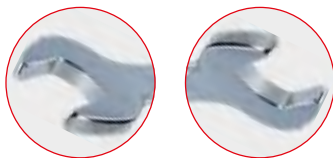

ab 30,00

A	517.0148			6x7 · 8x9 · 10x11 · 12x13 14x15 · 16x17 · 18x19 20x22 mm	30,00 CHF
B	517.0123			6x7 · 8x9 · 10x11 · 12x13 14x15 · 16x17 · 18x19 20x22 · 21x23 · 24x27 30x32 mm	68,00 CHF
C	517.0125			6x7 · 8x9 · 10x11 · 12x13 14x15 · 16x17 · 18x19 20x22 · 21x23 · 24x27 25x28 · 30x32 mm	75,00 CHF



- FlankTraction-Profil
- Maulstellung 15° abgewinkelt
- Ring 15° abgewinkelt
- polierte Köpfe
- matt satiniert



ab 35,00

A	517.0048			8 · 9 · 10 · 11 · 13 · 14 17 · 19 mm	35,00 CHF
B	517.0052			8 · 9 · 10 · 11 · 12 · 13 · 14 15 · 16 · 17 · 18 · 19 mm	65,00 CHF
C	517.0043			6 · 7 · 8 · 9 · 10 · 11 · 12 13 · 14 · 15 · 16 · 17 · 18 19 · 20 · 21 · 22 · 24 · 27 30 · 32 mm	165,00 CHF



- 12-kant
- DIN 838 / ISO 1085 / ISO 10104 / ISO 3318
- Ringe 75° gekröpft
- dünnwandig
- polierte Köpfe



ab 38,00

A	517.0248			6x7 · 8x9 · 10x11 · 12x13 14x15 · 16x17 · 18x19 20x22 mm	38,00 CHF
B	517.0222			6x7 · 8x9 · 10x11 · 12x13 14x15 · 16x17 · 18x19 20x22 · 21x23 · 24x27 30x32 mm	75,00 CHF



i **1**
Weitere Informationen

23,00

315 mm

22 mm

19 mm

522.1922

i **1**
Weitere Informationen

DIE 4 IN 1 WENDERATSCHKE

10 mm

13 mm

17 mm

19 mm

30,00

72°

5°

503.4565

10 x 13 x 17 x 19 mm

i **1**
Weitere Informationen

DAS MULTITALENT

Einhand-Multifunktions-Schlüssel

260 mm

8-17 mm

14-32 mm

114.0055

8 · 9 · 10 · 11 · 12 · 13 · 14 · 15 · 16 · 17 · 18 · 19 · 20 · 21 · 22 · 23 · 24 · 25 · 26 · 27 · 28 · 29 · 30 · 31 · 32 mm

51,00

i **12**
Weitere Informationen

72°

5°

180,00

503.4665

8 · 9 · 10 · 11 · 12 · 13 · 14 · 15 · 16 · 17 · 18 · 19 mm

i **30**
Weitere Informationen

DER ALLESKÖNNER

5/16" x 13 mm

1/2"

10 mm x 13 mm

3/8"

1/4" x 10 mm

1/4"

12 x

12 x

254,00

503.4960

8 · 9 · 10 · 11 · 12 · 13 · 14 · 15 · 16 · 17 · 18 · 19 mm

i **2**
Weitere Informationen

72 5°

1/2" 305 - 445 mm

1/4" 173 - 223 mm

VERSTELLBAR:
1/4" IN 4 STUFEN
1/2" IN 6 STUFEN

NEU **53,00**

914.1412

i **1**
Weitere Informationen

NEU 600 MM!

72 5°

1/2" 460 - 600 mm

Stufe: 1 2 3 4 5 6

38,00

VERSTELLBAR IN 6 STUFEN

914.1205

i **1**
Weitere Informationen

75,00

760 mm

**MAXIMALE FLEXIBILITÄT,
OPTIMALE KONTROLLE**

1/2"

918.1293

72 5°

**BESTÄNDIGE POWER –
INNOVATIVE FUNKTION**

A B C

1/4" 3/8" 1/2"

ab 38,00

			Nm	↔	
A	920.1490		1/4"	102	140 mm 38,00 CHF
B	920.3890		3/8"	325	190 mm 45,00 CHF
C	920.1290		1/2"	710	245 mm 55,00 CHF

102 Nm

710 Nm

72 5°

83,00

920.0002 **i** **2**
Weitere Informationen

DIE BESTEN, DIE WIR JE GEBAUT HABEN!

Wir wissen, was wir können. Und weil wir ganz genau wissen, wie gut unser neues Monster-Ratschen-Sortiment ist, ist es für uns selbstverständlich, Ihnen eine Garantie auf jedes Modell zu gewähren. Nicht 2 oder 3 Jahre. Nein, es sind gleich 10 Jahre! Damit die Garantie genauso Premium ist wie unsere Monster-Ratschen!



1 **80°** **45,00** **1/4"** **935.1490** **106 g** **125 mm** **>110 Nm**

i **1** **Weitere Informationen**



2 **80°** **45,00** **1/4"** **935.1495** **106 g** **125 mm** **>100 Nm**

i **1** **Weitere Informationen**

3 **96°** **60,00** **3/8"** **935.3890** **227 g** **199 mm** **>365 Nm**

i **1** **Weitere Informationen**



**GARANTIERT:
6 MONSTER
FÜRS LEBEN!**

4 **100°** **75,00** **1/2"** **935.1290** **567 g** **275 mm** **>950 Nm**

i **1** **Weitere Informationen**

5 **100°** **105,00** **1/2"** **935.1295** **757 g** **425 mm** **>950 Nm**

i **1** **Weitere Informationen**

6 **100°** **150,00** **1/2"** **935.1285** **1.280 g** **406 - 635 mm** **>950 Nm**

TELESKOPIERBAR

406 431 457 482 508 533 557 582 607 635 mm

i **1** **Weitere Informationen**

NEU **-15%** **935.0002** **>950 Nm** **105,00** **>110 Nm**

80° **45°** **1/4"** **1** **Weitere Informationen**

100° **3,6°** **1/2"** **2**

Alle Preise in CHF zzgl. MwSt. gelten bis 30.09.2024





9

Weitere Informationen

**Bit-Stecknuss-Satz
für Innensechskant-Schrauben, kurz**





3/8"



4 mm 5 mm 6 mm 7 mm 8 mm 9 mm 10 mm 12 mm 14 mm





NEU

53,00

917.4000

4 - 5 - 6 - 7 - 8 - 9 - 10 - 12 - 14 mm



BITTE EIN BIT. ABER KURZ!

10

Weitere Informationen

**Bit-Stecknuss-Satz
für Torx-Schrauben, kurz**

3/8"



T10 T15 T20 T25 T27 T30 T40 T45 T50 T55



NEU

60,00

917.4015

T10 - T15 - T20 - T25 - T27 - T30 - T40 - T45 - T50 - T55





77

Weitere Informationen

TORX TOTAL: ALLES IN EINEM KOFFER





5 x		1/4": E4 - E5 - E6 - E7 - E8
4 x		3/8": E10 - E12 - E14 - E16
4 x		1/2": E18 - E20 - E22 - E24
5 x		1/4": EPL4 - EPL5 - EPL6 - EPL7 - EPL8
4 x		3/8": EPL10 - EPL12 - EPL14 - EPL16
4 x		1/2": EPL18 - EPL20 - EPL22 - EPL24
8 x		1/4": T6 - T8 - T10 - T15 - T20 - T25 - T27 - T30
5 x		3/8": T40 - T45 - T47 - T50 - T55
2 x		1/2": T60 - T70
7 x		1/4": TB8 - TB10 - TB15 - TB20 - TB25 - TB27 - TB30
4 x		3/8": TB40 - TB45 - T50 - T55
1 x		1/2": TB60
7 x		1/4": IP8 - IP10 - IP15 - IP20 - IP25 - IP27 - IP30
3 x		3/8": IP40 - IP45 - IP50
2 x		1/2": IP55 - IP60
7 x		1/4": IPR8 - IPR10 - IPR15 - IPR20 - IPR25 - IPR27 - IPR30
3 x		3/8": IPR40 - IPR45 - IPR50
2 x		1/2": IPR55 - IPR60

-  E ✓
-  EPL ✓
-  TX ✓
-  TB ✓
-  IP ✓
-  IPR ✓

150,00

NEU



EVOLUTION SERIES

1/4" + 3/8" + 1/2"

911.0077



i **30**
Weitere Informationen

EVOLUTION SERIES

NEU

120,00

1/2"

911.4510

STAINLESS STEEL

55 mm	●	5 - 6 - 7 - 8 - 10 - 12 - 14 - 17 - 19 mm
100 mm	●	5 - 6 - 7 - 8 - 10 - 11 - 12 - 13 mm
140 mm	●	5 - 6 - 7 - 8 - 10 - 12 - 14 mm
200 mm	●	5 - 6 - 7 - 8 - 10 - 12 mm

i **32**
Weitere Informationen

EVOLUTION SERIES

NEU

120,00

1/2"

911.4520

STAINLESS STEEL

55 mm	★	M5 - M6 - M7 - M8 - M9 - M10 - M12 - M13 - M14
100 mm	★	M5 - M6 - M7 - M8 - M9 - M10 - M12 - M13 - M14
140 mm	★	M7 - M8 - M9 - M10 - M12 - M13 - M14
200 mm	★	M7 - M8 - M9 - M10 - M12 - M13 - M14

i **26**
Weitere Informationen

EVOLUTION SERIES

NEU

120,00

1/2"

911.4540

STAINLESS STEEL

55 mm	●	M5 - M6 - M8 - M9 - M10 - M12 - M14 - M16
100 mm	●	M5 - M6 - M8 - M9 - M10 - M12 - M14
140 mm	●	M5 - M6 - M8 - M9 - M10 - M12 - M14
200 mm	●	M8 - M10 - M12 - M14

i **32**
Weitere Informationen

EVOLUTION SERIES

NEU

120,00

1/2"

911.4550

STAINLESS STEEL

55 mm	★	T20 - T25 - T27 - T30 - T40 - T45 - T50 - T55 - T60 - T70
100 mm	★	T20 - T25 - T27 - T30 - T40 - T45 - T50 - T55 - T60 - T70
140 mm	★	T40 - T45 - T50 - T55 - T60 - T70
200 mm	★	T40 - T45 - T50 - T55 - T60 - T70

A matt satiniert **B** hochglanz verchromt

ab 42,00

vernickelt

A	917.0648		48	42,00 CHF	$1/4''$	
B	918.0648		48	45,00 CHF		 4 - 4,5 - 5 - 5,5 - 6 - 7 - 8 - 9 10 - 11 - 12 - 13 - 14 mm

90,00

matt satiniert

$1/2''$

10 - 11 - 12 - 13 - 14 - 15 - 16
17 - 18 - 19 - 20 - 21 - 22 - 24
27 - 30 - 32 mm

911.0620

i **20**
Weitere Informationen

A matt satiniert **B** hochglanz verchromt

ab 120,00

vernickelt

A	911.0694		94	120,00 CHF	$1/4'' + 1/2''$	
B	918.0694		94	135,00 CHF		 4 - 4,5 - 5 - 5,5 - 6 - 7 - 8 - 9 10 - 11 - 12 - 13 - 14 - 15 - 16 17 - 18 - 19 - 20 - 21 - 22 - 23 24 - 27 - 30 - 32 mm

135,00

matt satiniert

$1/4'' + 1/2''$

4 - 4,5 - 5 - 5,5 - 6 - 7 - 8 - 9
10 - 11 - 12 - 13 - 14 - 15 - 16
17 - 18 - 19 - 20 - 21 - 22 - 24
27 - 30 - 32 mm

911.0708

i **108**
Weitere Informationen



Weitere Informationen

1/4"	4 - 4,5 - 5 - 5,5 - 6 - 7 - 8 - 9 - 10 - 11 - 12 13 - 14 mm
1/4"	4 - 5 - 6 - 7 - 8 - 9 - 10 mm
	E4 - E5 - E6 - E7 - E8
	⊖ ⊕ ⊗ ⊙ ⊛ ⊜ ⊝
3/8"	10 - 11 - 12 - 13 - 14 - 15 - 16 - 17 - 18 19 mm
3/8"	10 - 11 - 12 - 13 - 14 - 15 mm
	E10 - E11 - E12 - E14 - E16 - E1
1/2"	10 - 11 - 12 - 13 - 14 - 15 - 16 - 17 - 18 19 - 20 - 21 - 22 - 24 - 27 - 30 - 32 mm
1/2"	16 - 17 - 18 - 19 - 22 mm
	E20 - E24
1/4"	⊖ ⊕ ⊗ ⊙ ⊛ ⊜ ⊝
5/16"	⊖ ⊕ ⊗ ⊙ ⊛ ⊜ ⊝
1/4" - 3/8"	50 - 100 - 125 - 150 - 250 mm
1/2"	1,3 - 1,5 - 2 - 2,5 - 3 - 4 - 5 mm
1/4" - 3/8"	
1/2"	
1/4" - 3/8"	1/4" - 5/16"
1/2"	
1/4"	

1/4" + 3/8" + 1/2"

vernickelt

matt satiniert



143,00

1/4"	4 - 4,5 - 5 - 5,5 - 6 - 7 - 8 - 9 - 10 - 11 12 - 13 - 14 mm
1/4"	6 - 7 - 8 - 9 - 10 - 11 - 12 - 13 - 14 15 mm
	⊖ ⊕ ⊗ ⊙ ⊛ ⊜ ⊝
3/8"	10 - 11 - 12 - 13 - 14 - 15 - 16 - 17 - 18 19 mm
3/8"	10 - 11 - 12 - 13 - 14 - 15 mm
1/2"	10 - 11 - 12 - 13 - 14 - 15 - 17 - 18 - 19 20 - 21 - 22 - 24 - 27 - 30 - 32 mm
1/2"	17 - 19 - 22 mm
	⊛
1/4"	⊖ ⊕ ⊗ ⊙ ⊛ ⊜ ⊝
5/16"	⊖ ⊕ ⊗ ⊙ ⊛ ⊜ ⊝
12 x	8 - 9 - 10 - 11 - 12 - 13 - 14 - 15 - 16 17 - 18 - 19 mm
	1,3 - 1,5 - 2 - 2,5 - 3 - 4 - 5 mm
1/4" - 3/8"	
1/2"	
1/4"	



A matt satiniert

B hochglanz verchromt

A 917.0216 216 263,00 CHF

vernickelt

B 918.0216 216 285,00 CHF

1/4" + 3/8" + 1/2"

ab 263,00



A	911.0721			21		19 · 21 · 22 · 23 · 24 · 26 · 27 · 29 · 30 32 · 35 · 36 · 38 · 41 · 46 · 50 mm	330, ⁰⁰ CHF
B	911.0722			21		19 · 21 · 22 · 23 · 24 · 26 · 27 · 29 · 30 32 · 35 · 36 · 38 · 41 · 46 · 50 mm	373, ⁰⁰ CHF
C	911.0751			21		3/4" · 13/16" · 7/8" · 15/16" · 1" 1.1/16" · 1.1/8" · 1.3/16" · 1.1/4" 1.5/16 · 1.3/8" · 1.7/16" · 1.1/2" 1.5/8" · 1.3/4" · 2"	373, ⁰⁰ CHF

ab
330,00

			82
Weitere Informationen			
1/4"			4 - 4,5 - 5 - 5,5 - 6 - 7 - 8 - 9 - 10 - 11 12 - 13 - 14 mm
1/2"			14 - 15 - 16 - 17 - 18 - 19 - 20 - 21 - 22 24 - 27 - 30 - 32 mm
1/4"			16 - 21 mm
1/4"			
5/16"			
1/4"			
1/2"			
1/4"			150 mm
1/4"			50 - 100 - 125 - 250 mm
1/2"			
1/4"			150 mm
12 x			8 - 10 - 11 - 12 - 13 - 14 - 17 - 19 - 22 mm



195,00

911.0682 **1/4" + 1/2"**

i  **47**
 Weitere Informationen

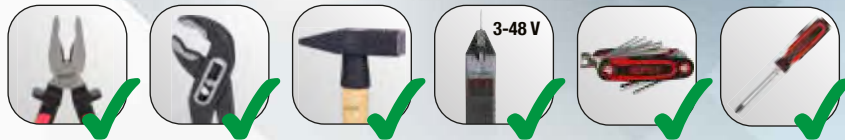

1/2"		10 - 11 - 12 - 13 - 14 - 15 - 16 - 17 18 - 19 - 20 - 21 - 22 - 24 mm
3 x		16 - 18 - 21 mm
14 x		6 - 7 - 8 - 9 - 10 - 11 - 12 - 13 - 14 15 - 16 - 17 - 18 - 19 mm
1 x		250 mm
2 x		125 - 250 mm
1 x		1/2"
5 x		3 - 5,5 - 8 mm PH1 - PH2
1 x		T8 - T10 - T15 - T20 - T25 - T27 T30 - T40
1 x		2,5 - 3 - 4 - 5 - 6 - 7 - 8 - 10 mm
1 x		3 - 48 V
1 x		240 mm
1 x		180 mm
1 x		300 g













225,00

matt
satinert

1/2"

940.0047



1/4"		4 - 4,5 - 5 - 5,5 - 6 - 7 - 8 - 9 - 10 11 - 12 - 13 mm
1/2"		10 - 11 - 12 - 13 - 14 - 15 - 16 - 17 19 - 20 - 21 - 22 - 24 - 27 - 30 - 32 mm
12 x		8 - 9 - 10 - 11 - 12 - 13 - 14 - 15 - 16 17 - 18 - 19 mm
2 x		1/4": 100 mm / 1/2": 125 mm
1 x		1/4" / 1/2"
7 x		3 - 4 - 5,5 - 6,5 mm PH0 - PH1 - PH2
1 x		T8 - T10 - T15 - T20 - T25 - T27 - T30 T40 - T45 - T50
1 x		1,5 - 2 - 2,5 - 3 - 4 - 5 - 6 - 8 - 10 mm
1 x		300 g
1 x		160 mm
1 x		200 mm



1/4" + 1/2"

A matt
satinert

B hochglanz
verchromt

A

917.0797



97

263,00 CHF

B

918.0797



97

285,00 CHF

vernickelt



ab
263,00



88

Weitere Informationen











5°
R
L



1/4"			4 - 4,5 - 5 - 5,5 - 6 - 7 - 8 - 9 - 10 - 11 12 - 13 mm
1/2"			14 - 15 - 16 - 17 - 18 - 19 - 20 - 21 - 22 23 - 24 - 25 - 26 - 27 - 28 30 - 32 mm
12 x			6 - 7 - 8 - 9 - 10 - 11 - 12 - 13 - 14 17 - 19 - 22 mm
3 x			1/4": 50 - 100 mm / 1/2": 125 mm
1 x			1/4"
4 x			6,5 - 8 mm + PH1 - PH2
1 x			1/4"
1 x			1/4"
1 x			150 - 250 V
1 x			250 mm
1 x			180 mm
1 x			300 g

285,00





matt satiniert

911.0688

1/4"
+ 1/2"



127

Weitere Informationen

DER ALLESKÖNNER



1



4 x

2



8 x 8 - 9 - 10 - 11 - 13
14 - 17 - 19 mm

3



4



555,00

911.0727

1/4"
+ 1/2"



490 mm

400 mm



Weitere Informationen



6 x



1/4"		4 - 4,5 - 5 - 5,5 - 6 - 7 8 - 9 - 10 - 11 - 12 13 mm
1/2"		10 - 13 - 14 - 15 - 16 17 - 18 - 19 - 21 - 22 24 - 27 - 30 - 32 mm
10 x		8 - 10 - 11 - 12 - 13 14 - 15 - 17 - 19 - 22 mm



585,00

911.0649

1/4" + 1/2"

**VOLLAUSSTATTUNG?
DANN HIER ZUGREIFEN!**



Weitere Informationen



6 x

3 x



9 x		1,5 - 2 - 2,5 - 3 - 4 - 5 - 6 8 - 10 mm
9 x		TS10 - TS15 - TS20 - TS25 TS27 - TS30 - TS40 - TS45 TS50



1/4"		4 - 4,5 - 5 - 5,5 - 6 - 7 8 - 9 - 10 - 11 - 12 13 mm
1/2"		10 - 11 - 12 - 13 - 14 15 - 16 - 17 - 18 - 19 21 - 22 - 24 - 27 - 30 32 mm
11 x		8 - 9 - 10 - 11 - 12 13 - 14 - 16 - 17 - 19 22 mm



675,00

911.0630

1/4" + 1/2"



Weitere Informationen

FÜR ELEKTRIKER

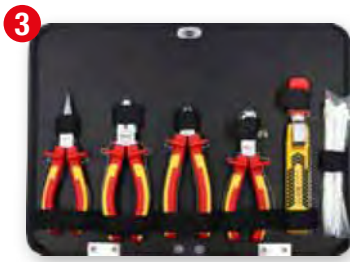

585,00

4 x

1/4" 4 - 4,5 - 5 - 5,5 - 6 - 7 - 8
9 - 10 - 11 - 12 - 13 mm

1/2" 10 - 11 - 12 - 13 - 14 - 15
16 - 17 - 18 - 19 - 21 - 22 mm

10 x 8 - 10 - 11 - 12 - 13 - 14
15 - 17 - 19 - 22 mm

911.0628

1/4" + 1/2"



Weitere Informationen

DER ALLROUNDER

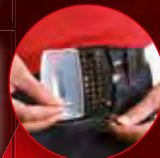

780,00

1/4" 4 - 5 - 6 - 7 - 8 - 9 - 11
12 - 13 mm

1/2" 10 - 11 - 12 - 13 - 14 - 15 - 16
17 - 18 - 19 - 21 - 22 - 24 mm

10 x 8 - 9 - 10 - 11 - 12 - 13
14 - 16 - 17 - 18 - 19 mm

911.0735



1/4" + 1/2"

i  **99**
Weitere Informationen

DIE SCHATZTRUHEN!

i  **99**
Weitere Informationen



	1/4" 4 - 5 - 6 - 7 - 8 - 9 - 10 - 11 - 12 13 - 14 mm
	1/2" 13 - 15 - 17 - 18 - 19 - 20 - 21 - 22 24 - 27 - 30 - 32 mm



RATSCHENRINGMAULSCHLÜSSEL

SIE HABEN DIE WAHL!

RINGMAULSCHLÜSSEL

8 - 9 - 10 - 11 - 12 - 13 - 14 - 15 - 16 - 17 - 18 - 19 mm

8 - 9 - 10 - 11 - 12 - 13 - 14 - 15 - 16 - 17 - 18 - 19 mm

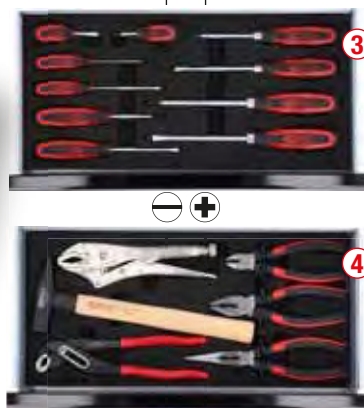

900,00

780,00

1/4" 1/2"

1/4" 1/2"



918.0100 

918.0200 

i  **40**
Weitere Informationen

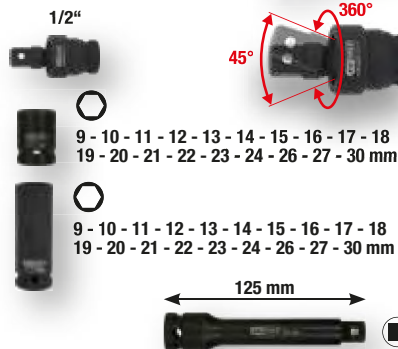

173,00

515.0065 **1/2"**



Weitere Informationen





1





ab
150,00

Skala mit Lupe

Mikrometerskala



mit Kaliber:
Normzertifizierung
DIN EN ISO 6799
Zertifikat
Gesamtgewicht
ca. 2,5 kg

		Nm	Teilung Nm	Lbf-ft		
516.1402		1/4"	1-5	0,10	0,8 - 3,6	150,00 CHF
516.1412		1/4"	5-25	0,10	0,8 - 18	150,00 CHF
516.1422		3/8"	10-50	0,25	4 - 37	150,00 CHF
516.1432		1/2"	20-100	0,50	8 - 75	167,00 CHF
516.1442		1/2"	40-200	1,00	15 - 150	167,00 CHF
516.1472		1/2"	60-320	1,00	45 - 236	188,00 CHF
516.1482		1/2"	80-420	1,00	60 - 310	204,00 CHF
516.1493		3/4"	150-750	10,00	150 - 550	884,00 CHF
516.1495		1"	200-1000	20,00	220 - 730	1011,00 CHF



3 IN 1



A



B

LANG

15,00

A	151.2100		 8	 2 - 2,5 - 3 - 4 - 5 - 6 8 - 10 mm	15,00 CHF
B	151.2300		 8	 T10 - T15 - T20 - T25 T30 - T40 - T45 - T50	15,00 CHF



Weitere Informationen





22



+ LANG

20,00

DIE WICHTIGSTEN 22
IN EINEM SATZ

151.4000

32
Weitere Informationen

vernickelt

1 x		1/4"
1 x		1/4"
3 x		PH1 - PH2 - PH3
6 x		2 x PZ1 - 2 x PZ2 - 2 x PZ3
3 x		5,5 - 6,5 - 8 mm
3 x		4 - 5 - 6 mm
15 x		2 x TB10 - 3 x TB15 - 2 x TB20 3 x TB25 - 3 x TB30 - 2 x TB40

911.2060

32
Weitere Informationen

TORION power

+30%

1 x		1/4"
1 x		1/4"
4 x		3 - 4 - 5 - 6 mm
4 x		PH1 - 2 x PH2 - PH3
4 x		PZ1 - 2 x PZ2 - PZ3
4 x		3 - 4 - 5 - 6 mm
7 x		T10 - T15 - T20 - T25 - T27 - T30 - T40
7 x		TB10 - TB15 - TB20 - TB25 - TB27 - TB30 - TB40

911.3030

14,00 15,00

108
Weitere Informationen

TORION power

25 mm

- 6x: 4 - 5 - 6 mm
- 6x: 4 - 5 - 6 mm
- 6x: PH1 - PH2 - PH3
- 6x: PZ1 - PZ2 - PZ3
- 6x: T10 - T15 - T20 - T25 - T30 - T40

918.3108

45,00

NEU

TORION power

+30%

108 BITS, DIE DEN UNTERSCHIED MACHEN

32
Weitere Informationen

68 mm

100 mm

4 x		3 - 4 - 5 - 6 mm
4 x		PH1 - 2 x PH2 - PH3
4 x		PZ1 - 2 x PZ2 - PZ3
4 x		3 - 4 - 5 - 6 mm
7 x		T10 - T15 - T20 - T25 T27 - T30 - T40
7 x		TB10 - TB15 - TB20 - TB25 TB27 - TB30 - TB40

918.3010

68,00

TORION power

-22,1%

-49%

31
Weitere Informationen

4 - 5 mm

2 x		4 - 5 mm
3 x		PH1 - PH2 - PH3
3 x		PZ1 - PZ2 - PZ3
9 x		1,5 - 2 - 2,5 - 3 - 4 - 5 - 6 7 - 8 mm
11 x		T6 - T7 - T8 - T9 - T10 - T15 T20 - T25 - T27 - T30 - T40

918.3015

87,00

TORION power

i **24**
Weitere Informationen

KLEIN & FEIN

25 mm
vernickelt

30,00

1 x		1/4": 92 mm
1 x		1/4": 50 mm
1 x		1/4"
6 x		6 - 7 - 8 - 10 - 11 - 13 mm
2 x		PH1 - PH2
2 x		PZ1 - PZ2
2 x		4,5 - 5,5 mm
4 x		3 - 4 - 5 - 6 mm
5 x		TB10 - TB15 - TB20 - TB25 - TB30

911.2010 **1/4"**

i **208**
Weitere Informationen

60,00

DER ALLES-SCHRAUBER!

1/4"		1/4": 205 mm
138 x		25 mm
29 x		50 mm
18 x		75 mm
20 x		4 - 5 - 6 - 7 - 8 - 9 - 10 - 11 - 12 - 13 mm 5/32" - 3/16" - 7/32" - 1/4" - 9/32" 5/16" - 11/32" - 3/8" - 7/16" - 1/2"
1 x		1/4": 50 mm
1 x		1/4"

911.2008 **1/4"**

i **7**
Weitere Informationen

DAS KLEINE TECHNIKWUNDER!

15,00

6 IN ONE

110 mm

NEU

- 4 - 5 mm
- PH1 - PH2
- PZ1 - PZ2

911.2025 **1/4"** **6 in 1 Mini-Ratschen-Schraubendreher**

i **13**
Weitere Informationen

23,00

12 IN ONE

240 mm

- 4 - 5 - 6 mm
- PH1 - PH2 - PH3
- 3 - 4 - 5 mm
- T15 - T20 - T25

911.2035 **1/4"** **12 in 1 Ratschen-Bit-Schraubendreher**

1
Weitere Informationen

2 IN 1

1/4"

85 mm

14,00

514.1126

1
Weitere Informationen

1/4"

17,00

MIT GELENK

90 mm

514.1136

21
Weitere Informationen

4 mm

30 mm **165 mm**

Ø 16 mm

60,00

500.7195

1 - 1,3 - 1,5 - 2 - 2,5 - 3 mm

PH00 - PH0 - PH1 - PH2

1,5 - 2 - 2,5 - 3 - 3,5 mm

T3 - T4 - T5 - T6 - T7

Max USB

27
Weitere Informationen

LED

1/4"

eMONSTER

KSTOOLS

Einmal berührt, für immer verführt.

53,00

515.3600

max 6 Nm

max 4 Nm

max 2 Nm

4x		3,0 - 4,0 - 5,0 - 6,0 mm
4x		3,0 - 4,0 - 5,0 - 6,0 mm
5x		PH0 - PH1 - PH2 - PH3
4x		PZ0 - PZ1 - PZ2 - PZ3
4x		T10 - T15 - T20 - T25
4x		#0 - #1 - #2 - #3
1x		PH1
1x		50 mm
1x		Max. 6 Nm

3,6 V **1.500 mAh** **300 rpm** **USB-C** **2+ LED**



Weitere Informationen

DER ALLROUNDER



1 Bohren



2 Reinigen



3 Schleifen



4 Gravieren

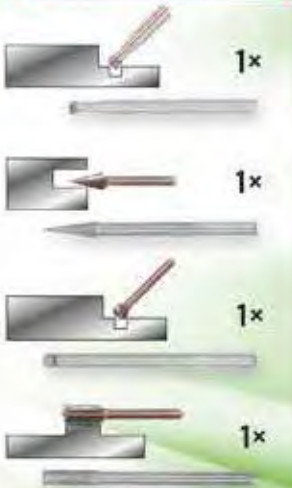

5 Trennen



6 Polieren



eMONSTER
Akku-Multifunktions-
werkzeug-Satz mit
50 Zubehörteilen



eMONSTER



75,⁰⁰

515.3990



Weitere Informationen

ZUM NACHKAUFEN



Zubehör-Satz, 50-tlg

15,⁰⁰

515.3992

DER TRANSFORMER UNTER DEN SCHRAUBERN



eMONSTER

Hohe 210 RPM
Drehzahl, dadurch
5 x schneller als
manueller
Anziehvorgang

praktische Batterie-
Ladezustandsanzeige
mit 3 LEDs

verstärktes
Getriebe



2 in 1 Gerät mit ausgewogenem Verhältnis zwischen Leistung und Größe, ideal zum Arbeiten über Kopf und an engen Stellen.

magnetische
Bitaufnahme



Drehmomentvorwahl in
10 Stufen einstellbar



verbesserter
Griffkomfort



1.3 Ah Akku
mit einer Laufzeit
für
1000+
Schrauben

Der Li-ION-Hochleistungsakku
ist dank USB-C Anschluss auch
schnell wieder aufgeladen und
einsatzbereit.

integrierte Lampe



Ein Überdrehen der Schrauben wird
durch automatisches Verriegeln
des Motors bei Überschreiten des
Drehmoments verhindert.



Weitere Informationen

inkl.
25 Bits



60,00

515.6500

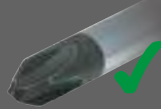

verchromt mit
brünierter Spitze



mit Profilkennzeichnung
am Griff

i **5** **159.0005**

Weitere Informationen

15,00

PH1 PH2 6,5 mm 5,5 mm 4 mm

i **6** **159.0030**

Weitere Informationen

30,00

T10 T15 T20 T25 T30 T40

i **6** **159.0040**

Weitere Informationen

30,00

TB10 TB15 TB20 TB25 TB30 TB40

i **39**

Weitere Informationen

77,00

6 x		3 - 4 - 5,5 - 6,5 8 - 10 mm	7 x		2 - 2,5 - 3 - 4 - 5 6 - 8 mm
5 x		PH0 - PH1 - PH2 PH3 - PH4	7 x		TB10 - TB15 - TB20 TB25 - TB27 - TB30 TB40
4 x		PZ0 - PZ1 - PZ2 PZ3	7 x		T10 - T15 - T20 T25 - T27 - T30 T40
1 x		6 mm	1 x		1/4"
1 x		PH2	1 x		205 mm

159.0100 **1/4"**

i **13**

Weitere Informationen

**DER VERTRÄGT
SCHLÄGE!**

102,00

durchgehende Klinge

5 x		3,5 - 5,5 - 7 - 8 - 10 mm
5 x		PH0 - PH1 - PH2 - PH3 - PH4
1 x		6 mm
1 x		PH2
1 x		1/4"

151.1150 **1/4"**

i **15**
Weitere Informationen

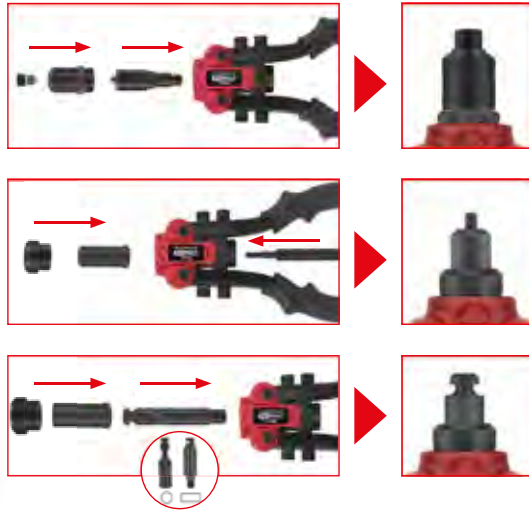

102,00

150.9805



Niete (Alu)

Niete (Stahl)

Mutter

		A	B
		150.9805	150.9630
	im Koffer	✓	✓
	Länge mm	260	510
	Blechknabber	✓	✗
	Ein- oder Zweihand- Bedienung		
	M10	✓	✓
	M8	✓	✓
	M6	✓	✓
	M5	✓	✓
	M4	✓	✓
	M3	✓	✓
	Stahl 4,8 mm	✓	✓
	Stahl 4,0 mm	✓	✓
	Stahl 3,2 mm	✓	✓
	Stahl 2,4 mm	✓	✓
	ALU 6,4 mm	✓	✓
	ALU 4,8 mm	✓	✓
	ALU 4,0 mm	✓	✓
	ALU 3,2 mm	✓	✓
	ALU 2,4 mm	✓	✓

i **17**
Weitere Informationen

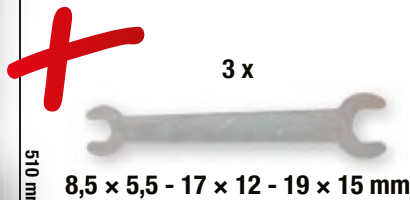

3 x
8,5 x 5,5 - 17 x 12 - 19 x 15 mm



5 x
M4 - M5 - M6 - M8 - M10



6 mm

263,00

150.9630





1
Weitere Informationen





ab 17,00



35 - 90 mm



	↔	↔	
115.2011	175 mm	7"	17,00 CHF
115.2010	240 mm	10"	20,00 CHF
115.2012	300 mm	12"	24,00 CHF
115.2016	415 mm	16"	48,00 CHF

4
Weitere Informationen

CrV DIN 5254 A DIN 5254 B DIN 5256 C DIN 5256 D

PREMIUM QUALITÄT!

4
Weitere Informationen



A 19 - 60 mm



B 40 - 100 mm

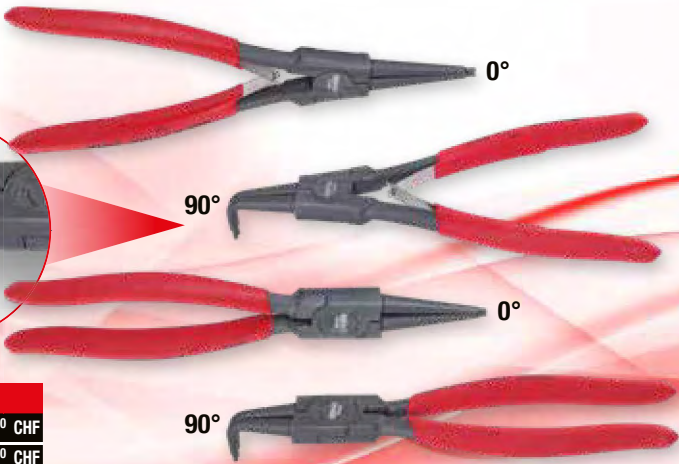

ab 167,00

	↺ ↻	↔	
A	119.2055	19 - 60 mm	160 mm 167,00 CHF
B	119.2060	40 - 100 mm	230 mm 188,00 CHF





20
Weitere Informationen

SAFETY FIRST



60 - 100 mm



40 - 85 mm



75,00





0° 15° 45° 90°



90° 45° 15° 0°



500.1350

Sicherungszangen-Satz mit Ratschenfunktion

i  **10**
Weitere Informationen

SCHAU MIR IN DIE AUGEN, FEINES!

i  **21**
Weitere Informationen

38,00

260 mm

300 mm

1 x		120 mm	1 x		160 mm
1 x		120 mm	3 x		PH00 - PH0 - PH1
1 x		120 mm	3 x		2,0 - 2,4 - 3,0 mm

500.7220  

150,00

ESD

430 mm

370 mm

2 x		125 - 130 mm	3 x		PH00 - PH0 - PH1
1 x		100 mm	4 x		1,4 - 2,0 - 2,4 - 3,0 mm
1 x		100 mm	7 x		T6 - T7 - T8 - T9 - T10 - T15 - T20
1 x		125 mm			
1 x		150 mm			
1 x		145 mm			

500.7190   

i  **1**
Weitere Informationen

 500g

mit stabiler, reissnadelähnlicher Einstellspitze

Ø 8,0 mm

150 - 675 mm

9,00

mit starrem Magnet-Kopf

550.1001 2in1 Teleskop-Magnethalter mit Waschdüsen-Reinigungs- und Einstellwerkzeug

i  **1**
Weitere Informationen

 2,5 kg

mit dünnem Reinigungsstab

Ø 11,0 mm

150 - 590 mm

12,00

mit flexiblem Magnet-Kopf

550.1023 2in1 Teleskop-Magnethalter mit Waschdüsen-Reinigungs- und Einstellwerkzeug

i  **1**
Weitere Informationen

15,00

50 x 80 mm

260 - 760 mm

max. 60 h

1 x CR 2032

LED

550.1136 Flexibler Inspektions-Spiegel mit Beleuchtung

i  **5**
Weitere Informationen

LED

3 x LR44

Ø 52,0 mm

Ø 31,0 mm

90,0 x 50,0 mm

23,00

5 IN 1

inklusive Schnellverriegelung

172 - 640 mm

550.1145

i **4**
 Weitere Informationen

15,00

45° 135° 0° 90°

550.1045

i **9**
 Weitere Informationen

30,00

45° 135° 0° 90° 45° 90° 0°

550.1070

i **1**
 Weitere Informationen

14,00

Piezo

115 mm

960.1110

i **1**
 Weitere Informationen

30,00

300 mm

550.1060

i **8**
 Weitere Informationen

30,00

95 mm

Ø 40 mm

49 mm

5 mm

Ø 1,6 mm

Ø 3,5 mm

Ø 4,5 mm

960.1265

i **11**
 Weitere Informationen

45,00

Piezo

200 mm

20 mm

33 mm

Ø 1,6 mm

Ø 3,5 mm

Ø 4,5 mm

Ø 5 mm

30 mm

95 mm

95 mm

Ø 40 mm

ISO BUTAN

960.1160 Mikro-Löt-Satz

i **283**
Weitere Informationen

255,00

220 mm

Ø 0,5 - 6 mm
Ø 0,5 - 6 mm
Ø 0,5 - 10 mm
Ø 6,50 / 5,41 / 1,72 mm
Ø 0,5 - 4 mm
Ø 1,0 - 3,2 mm

115.1400

i **1**
Weitere Informationen

6,00

143 mm

118.0013

i **1**
Weitere Informationen

ab 5,00

EG II

A 16 mm
B 19 mm
C 25 mm
D 25 mm

	Artikelnummer	Länge	Blattbreite	Preis
A	300.0113	3 m	16 mm	5,00 CHF
B	300.0114	5 m	19 mm	6,00 CHF
C	300.0115	5 m	25 mm	8,00 CHF
D	300.0116	8 m	25 mm	9,00 CHF

i **5**
Weitere Informationen

45,00

260 mm

Temperaturregulierung:
1≈50°C / 2≈100°C / 3≈200°C /
4≈350°C / 5≈550°C / 6≈650°C

1 max. 450°C
2 max. 650°C

Anwendungsgebiete: Entfernen von Farbe, Verlöten von Rohren, Schrumpfen von PVC, Verschweißen und Biegen von Kunststoffen, Trocknungen, Auftauen etc.

960.1190

i **1**
Weitere Informationen

203,00

IP 34

15+1 m

3x 1,5 mm²

230 V
50 Hz

1000/3000 W

10 A

150.4217

i **12**
Weitere Informationen

15,00

145 mm

5,0 x 1,0 mm
5,0 x 1,0 mm
3,0 mm
3,0 mm
5,0 mm
5,0 mm
3,0 mm
2,0 mm
2,0 mm
5,0 mm
5,0 mm
5,0 mm

140.3050

i **5**
Weitere Informationen

45,00

200 mm

140.3000

i **1**
Weitere Informationen

138 x 69 x 31 mm 342 9 V Data Hold

30,00

69 mm 138 mm

150.1495

i **1**
Weitere Informationen

3 - 48 V

140 mm

18,00

550.1503 Polaritäts- und Spannungsprüfer 3 - 48 V

i **1**
Weitere Informationen

125 mm

6 - 24 V

8,00

550.1504 Prüflampe 6 - 24 V

i **1**
Weitere Informationen

AUTOMATIC
DIGITAL MULTIMETER

143 x 70 x 16 mm 119 AAA Data Hold

16 mm

143 mm

70 mm

75,00

150.1765

Nr. Beschreibung

- Ein-/Aus-Taste
- Funktionsschalter
- Kapazitätsschalter
- Beleuchtungsschalter
- LCD-Display
- NCV-Sensor-Bereich
- Messleitungen

Symbol Beschreibung

DC	Gleichspannung
AC	Wechselspannung
	Anzeige für automatische Abschaltfunktion
	Anzeige für niedrigen Batteriestand
	Dioden-Modus
	Durchgang
	Kapazität
%	Leistungsmessverhältnis
HOLD	Data-Hold-Funktion
V, mV	Einheit der Spannung: Volt, Millivolt
mF, µF, nF	Einheit der Kapazität
MΩ, KΩ, Ω	Einheit des Widerstands
NCV	Kontaktlose Spannungsinduktion
Live	Prüfung spannungsführender Leitungen
KHz, Hz	Einheit der Frequenz
°C/°F	Celsius/Fahrenheit

NCV

3 COLOUR ANALOG BAR

BUZZER ALARM

USB-A

USB-C

i **3**
Weitere Informationen

210 x 88 x 44 mm
655
9 V
Data Hold

53,00

max. messbarer Leiterdurchmesser 29,0 mm

150.0925

i **1**
Weitere Informationen

für Gleich- und Wechselspannung

AC	6 - 50 - 120 - 230 - 400 V
DC	6 - 50 - 120 - 230 - 400 V

36,00

550.1501

UNIVERSAL-SCHLITTSCHLÜSSEL

i **1**
Weitere Informationen

MINI

42 mm

- 6 - 7 - 8 mm
- 9 mm
- 3 - 5 mm
- PH 2
- 7 mm

26,00

130.1010

i **1**
Weitere Informationen

71 mm

- 6 - 7 - 8 mm
- 9 mm
- 3 - 5 mm
- PH 2
- 7 mm

27,00

130.1015

i **1**
Weitere Informationen

61 mm

- 5 - 7 - 8 mm
- 9 - 10 mm
- 4 - 10 mm
- PH 2
- 7 mm

27,00

130.1020

Kabel-Einziehdraht

10 Meter
20 Meter

ab 8,00

A	150.0960		1	∅ 3,0 mm 10 m	8,00 CHF
B	150.0970		1	∅ 4,0 mm 20 m	15,00 CHF

i **1**
Weitere Informationen

53,00

∅ 3,0 mm

30 Meter

115.1113 Kabeleinziehilfe

i **1**
Weitere Informationen

35,00

- mit Momentfeststellung
- Messschiene in mm und Zoll-Teilung
- mit Gewindetabelle

300.0510

i **1**
Weitere Informationen

38,00

+ 15.20
+/- 0.03 mm

- mit Feststellschraube und Rollenfeineinstellung
- für Außen-, Innen-, Stufen- und Tiefenmessungen

300.0532

i **1**
Weitere Informationen

INFRAROT-THERMOMETER, -38° BIS 520°

75,00

150.3040

i **4**
Weitere Informationen

86,00

550.1290

Refraktometer - optisches Prüfgerät für Batterieflüssigkeit und Frostschutzmittel

i **4**
Weitere Informationen

102,00

550.1285

Refraktometer - optisches Prüfgerät für Batterieflüssigkeit, Frostschutzmittel und AdBlue®-Zusätze

i **4**
Weitere Informationen

30,00

11 x 115 mm
15 x 185 mm
18 x 320 mm
18 x 470 mm

911.8100 **Hebeleisen-Satz**

i **4**
Weitere Informationen

XL

900 mm
600 mm

0°
45°
75°
90°

270,00

911.8410 **Hebeleisen-Satz**

i **22**
Weitere Informationen

700.1200

**Hydraulischer Universal-Abzieher-Satz
2+3-armig**

- geringe Abrutschgefahr durch automatisch schließende Abzieherarme
- 8 Abziehervarianten möglich
- extrem robuste Spindel mit induktiv gehärtetem Gewinde
- geringer Kraftaufwand
- Spezial-Werkzeugstahl

458,00

10 t, AG 1.1/2" x 16G

20 - 35 - 85 mm
235 mm
185 mm
225 mm
170 mm
120 mm
Ø max. 100 mm

701

i **13**
Weitere Informationen

NEU

FÜR NOTFÄLLE

120,00

0% **85%**

zum Lösen und Herausdrehen von festsitzenden Muttern und Schrauben mit beschädigten oder bis zu 85% „rundgedrehten“ Köpfen

135,00

Ringe 45° gekröpft

3/8"

517.1555 6x7 - 8x9 - 10x11 - 12x13 - 14x15 - 16x17 - 18x19 mm

3/8"

3/8" **1/2"**

913.3930 8 - 9 - 10 - 11 - 12 - 13 - 14 - 15 - 16 - 17 - 18 - 19 mm

7
Weitere Informationen

ICH BIN EINE SCHRAUBE, HOLT MICH HIER RAUS!

i  **6**
 Weitere Informationen

- für Schrauben von M3 - M18
- ermöglicht das Ausdrehen von abgerissenen Schrauben und Bolzen
- konisch zulaufende Spirale
- in stabiler Kunststoffbox

26,00







150.1330 Schrauben-Ausdreher-Satz

i  **34**
 Weitere Informationen

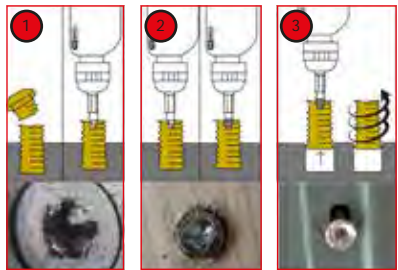
TORXION power

68,00



9 x		TE10 - TE15 - TE20 - TE25 - TE27 - TE30 - TE40 - TE50 - TE55
9 x		1,5 - 2 - 2,5 - 3 - 4 - 5 - 6 - 8 - 10 mm
7 x		1,5 - 2 - 2,5 - 3 - 4 - 5 - 6 mm
7 x		T10 - T15 - T20 - T25 - T27 - T30 - T40

150.7060 1/4" + 10 mm Torx- und Innensechskant-Schrauben-Ausdreher-Satz

i  **25**
 Weitere Informationen

Gewindeausdreh-Satz

- umfangreiche Satzzusammenstellung
- zum Entfernen von abgebrochenen Gewindebolzen und Schrauben
- keine Beschädigung des Gewindes
- nur geringfügiges Aufweiten der Gewindebolzen durch speziell profilierte Ausdrehstifte

Führungshülse drill guide	Hülse Innen-Ø mm guide	vorböhren Ø mm pre-drilling	aufbohren re-drilling	Stift pin	Art.Nr. Stift No. Pin	Mutter D nut D	Art.Nr. Mutter nut D	Stift + Mutter pin + nut
150.0501	4,0 / 3,2	3,2	-	3,2	150.0521	SW 10	150.0511	150.0511S
150.0502	4,8 / 3,2	3,2	-	3,2	150.0521	SW 10	150.0511	150.0511S
150.0503	4,8 / 3,2	3,2	4,8	4,8	150.0522	SW 11	150.0512	150.0512S
150.0504	4,8 / 3,2	3,2	4,8	4,8	150.0522	SW 11	150.0512	150.0512S
150.0505	6,0 / 4,8	4,8	6,4	6,4	150.0523	SW 13	150.0513	150.0513S
150.0506	7,0 / 4,8	4,8	6,4	6,4	150.0523	SW 13	150.0513	150.0513S
150.0507	7,0 / 4,8	4,8	8,0	8,0	150.0524	SW 14	150.0514	150.0514S
150.0508	7,0 / 4,8	4,8	8,7	8,7	150.0525	SW 17	150.0515	150.0515S
150.0509	9,0 / 6,5	6,4	8,7	8,7	150.0525	SW 17	150.0515	150.0515S
150.0510	9,5 / 6,5	6,4	8,7	8,7	150.0525	SW 17	150.0515	150.0515S



150.1305 M5 - M6 - M8 - M10 - M12 - M14 - M16

60,00

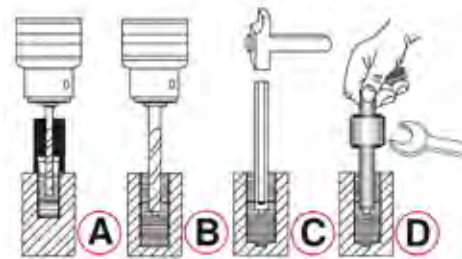



Weitere Informationen

Stehbolzen-Ausdreher-Satz

- Außensechskantantrieb 21,0 mm
- mit Rechts- und Linksspannfunktion
- sicherer Halt durch je 3 Rollwalzen
- Ein- und Ausdrehen ohne umständliches Verkontern zweier Muttern auf dem Bolzen
- auch für überlange Stehbolzen geeignet - da durchgehend gebohrt

75,00

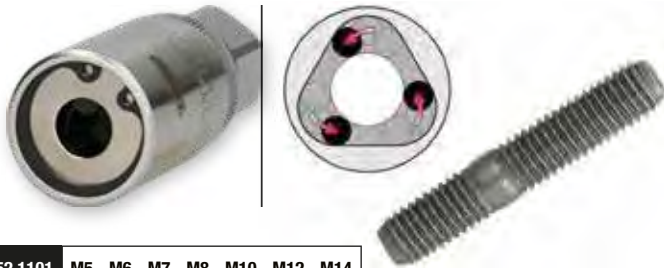

152.1101 M5 - M6 - M7 - M8 - M10 - M12 - M14



Weitere Informationen

HSS Co Gewindeschneidwerkzeug-Satz in Industriekassette

- universaler Satz
- gerade genutete Handgewindebohrer
- mit verstellbarem Windeisen und Schneideisenhalter
- inklusive Gewindelehre und Schraubendreher
- kobaltierter Hochleistungs-Stahl



DEM FEHLT ES AN NICHTS



33 x		M3 - M4 - M5 - M6 - M8 - M10 - M12 M14 - M15 - M18 - M20
11 x		M3 - M4 - M5 - M6 - M8 - M10 - M12 M14 - M15 - M18 - M20
6 x		M3-M4 - M4,5-M6 - M7-M9 - M10-M11 - M12-M14 - M16-M20
2 x		M1-M10 - M5-M20

750,00

331.0754



Weitere Informationen

TRÄGT JEDER GERNE!



38,00

EN388



4131X

Mikro-Feinstrick

	Größe	Inhalt
310.0490	7	12 Paar
310.0491	8	12 Paar
310.0470	9	12 Paar
310.0475	10	12 Paar
310.0480	11	12 Paar



Weitere Informationen

6,00



310.0120

FLAME DESIGN

Weitere Informationen

75,00

310.0155

STEEL DESIGN

Weitere Informationen

75,00

310.0195



Technische Daten:

Farbauswahl:	stufenlos regelbar von DIN 9-13 Standard Lichteinstellung: DIN 4
Umschaltreaktionszeit:	1/25.000 s 0,2 - 0,8 s Verzögerung (einstellbar)
UV / IR Schutz:	nach EN169 / bis DIN 16
Betriebstemperatur:	-5°C bis + 55°C
Lagertemperatur:	-20°C bis + 70°C
Stromversorgung:	über Solarzellen
Höhe:	220 mm
Breite:	200 mm
Länge:	295 mm
Gewicht:	480 g
Maße Kassette:	110 x 90 x 9 mm
Sichtfenster:	92 x 42 mm

Universal-Druck-Zerstäuber

Weitere Informationen

- aus hochwertigem Polyethylen
- für verschiedene Chemikalien wie z.B. Wasch-, Lösungs- und Reinigungsmittel etc.
- für Bremsenreiniger ungeeignet
- Sprühkopf aus Messing verstellbar und verschleißbar
- Dichtungen aus Viton®
- geeignet für Überkopf-Arbeiten

für Bremsenreiniger ungeeignet

ab 23,00

150.8251	1 L	23,00 CHF
150.8252	2 L	30,00 CHF

Aluminium

Weitere Informationen

0,25 L
max. 8 bar (116 psi)
60°C / 140°F

NEU

Speziell für Bremsenreiniger

75,00

150.8272

i **16**
Weitere Informationen

EVOLUTION SERIES

Schaber-Satz

- ideal zum Entfernen von Plaketten, Dichtungs- und Klebstoffresten
- einfacher Klingenwechsel durch Lösen der Rändelschraube am Spannfutter
- praktisches Aufbewahrungssystem durch wechselbare Klingensformen
- bestens geeignet für unterschiedlichste Anwendungsbereiche durch verschiedene Klingen
- Schaber mit 2-Komponentengriff

Ersatzklingen: 907.2202, 907.2203, 907.2204, 907.2205, 907.2206

NEU

5x 12 mm
5x 16 mm
5x 20 mm

145 mm

20,00

907.2255

i **27**
Weitere Informationen

Messer-Schaber-Satz

145 mm

5x 19 mm

5x 12 mm
5x 16 mm
5x 16 mm
5x 20 mm

145 mm

30,00

907.2200

Plakettschaber

A 110 mm **B** 145 mm

ab 6,00

A	907.2240			1	110 x 39 mm	6,00 CHF
B	907.2242			1	145 x 40 mm	8,00 CHF

Klappmesser mit Arretierung

A 190 mm **B** 220 mm

A	907.2105			1	190 x 25 mm	17,00 CHF
B	907.2190			1	220 x 28 mm	18,00 CHF

ab 17,00

i **2**
Weitere Informationen

23,00

155 mm 97 mm

+

907.2172 **Klappmesser-Satz**

i **3**
Weitere Informationen

60,00

250 mm

+ **+** **+**

118.0050 **Hebel-Blechdurchgangsscheren-Satz**

Wi-Fi-Videoskop-Satz mit Ø 5,5 mm 0° HD Frontkamera-Sonde

HD

WiFi

Ø 5,5 mm

IP68

3500 mm

60,00

550.7560

EXTEND YOUR EYE

ab 360,00

Edelstahlhülse
Schraubanschluss
für Zubehör

Kronendesign
(Schutz +
optimale
Reinigung)

Kamera
Linse
LED
Edelstahlhülse
mit Außengewinde
Saphirglas

1500 mAh
Li-polymer

HD

6 dimmbare
Mini-LED-
Lampen

Ø

Ø 6,0 mm

Ø 4,5 mm

0° / 90°

0° / 90°

1000 mm

50 mm

3,5"

USB 2.0

microSD

Magnet

Magnet

Haken

IP 67

AVI
1280 x 720

JPG

150 mm

-10°/+60°C

A	550.7500			6,0 mm	0° + 90°	360,00 CHF
B	550.7530			4,5 mm	0° + 90°	450,00 CHF



i  **3**
Weitere Informationen

Ø
3,9 mm

6 dimmbare
Mini-LED-
Lampen

1000 mm
90 mm

0°
steuerbar
180° **180°**

drehbar
drehbar
360°

Anschluss Sonde

USB 2.0

microSD

3000 mAh
Li-polymer

IP
67

AVI
1280 x 720

JPG

150 mm

-10°/+60°C

NEU

675,00

+ 32 GB

550.7550 HD-Videoskop-Satz mit Ø 3,9 mm 180° und 0° HD Frontkamera-Sonde, flexible PVC Hülle





Ø 12 - 35 MM



104.5060

Inox

Steel

Ratschen-Rohrabschneider



60,00



Ø 28 - 67 MM



104.5050

Inox

Steel

Ratschen-Rohrabschneider



195,00



116.1050

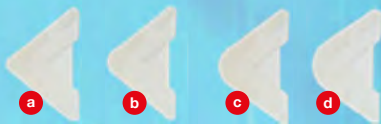

FUGENFIX[®]

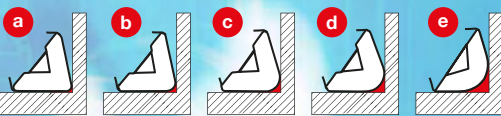

12,00



FUGENFIX Silikonschaber- und Abziehersatz



903.3300

Gewinde-Schneidkluppen-Satz

3/8"
1/2"
3/4"
1"
1.1/4"

120,00



116.2000



87,00

Ventifix

130.3000

1/2"



3/8" - 1/2"
3/4" - 1"

90 mm

270 mm



30,00

Universal-Stufenschlüssel-Satz 3/8" - 1"

903.5902

- Flammentemperatur ca. 1700°C
- Arbeitstemperatur ca. 650°C
- Weichlöten bis max. Ø 22 mm
- Lieferung erfolgt ohne Gaskartusche
- Verwendung nur mit Standard-Hochleistungsbrenner
- Grundkörper aus Kunststoff



38,00

Universal-Kartuschenlötgerät mit Piezo-Zündung

907.2113

Japan-Zugsäge, doppelverzahnt



17x pro 2,5cm

8x pro 2,5cm

325 mm

27,00



850.0300

SMARTBAG Universal-Werkzeugtasche

111,00

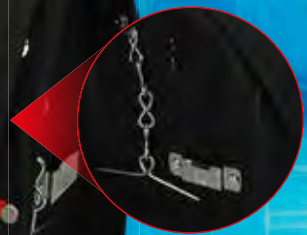

NEU



Kompakte und robuste Bauweise:

Durch hochwertige Kunststoffe und feste Verschraubungen, bietet der Akku besonders guten Schutz vor mechanischen Einflüssen.



18V eMONSTER Akku-System

Das kraftvolle 18V eMONSTER Akku-System vereint eine Reihe von professionellen akkubetriebenen Elektrowerkzeugen. Alle Geräte können mit einem Akku-System betrieben werden. Das Sortiment ist breit aufgestellt und wird stetig erweitert. Jedes neue Gerät kann ebenso mit diesem Akku-System genutzt werden. So können Sie über viele Jahre dieses Akku-System nutzen und mit eMONSTER 18V Geräten erweitern - Sie bleiben in einer Akku-Familie.



Wärmeableitung:

Durch die Rippenstruktur wird die Wärme wie bei einem Kühler an die Umgebungsluft angeleitet.



Zusätzlicher Schutz für eine lange Lebensdauer des Akkus:

Überspannungsschutz:

- Schutz vor unzulässig hohen Spannungsquellen

Niederspannungsschutz:

- Schutz vor Tiefenentladung im Betrieb

Temperaturmanagement:

- Zusammenspiel von Gerät und Akku, um eine Überlastung am Akku zu verhindern



Aktive Luftkühlung:

(nur bei 8.0Ah Schnellladegerät) Der integrierte Lüfter des 8.0Ah Schnellladegeräts liefert während dem Ladevorgang durchgehend kühle Frischluft, um entstehende Wärme im Akku und Ladegerät bestmöglich zu reduzieren. Durch diesen schonenden Ladevorgang wird die Lebensdauer des Akkus deutlich erhöht.



Optimierte Zellanordnung:

Durch die Röhrenstruktur werden die einzelnen Zellen in den wärmeleitenden Kunststoff geschoben. So entsteht ein fester Kontakt zwischen der Zelle und dem wärmeleitenden Kunststoff. Es ist keine isolierende Luftschicht mehr vorhanden, welche die Wärmeableitung verringert.





eMONSTER Brushless-Akku-Bohr-Schrauber-Satz

MINI



240,00

Drehmoment max: 40 Nm
Antrieb: 10 mm Schnellspann-Bohrfutter

515.6400



eMONSTER Brushless-Akku-Schlag-Bohr-Schrauber-Satz



285,00

Drehmoment max: 60 Nm
Antrieb: 13 mm Röh-Metall-Schnellspann-Bohrfutter

515.6300

INKLUSIVE



Akkuspannung: 18,0 V
max. Ladestrom: 3 A

Akkuspannung: 18,0 V
Akkutechnologie: Lithium-Ionen
Akkukapazität: 2,0 Ah

Lieferung inkl. zwei 2,0 Ah Akkus und 3 A Schnellladegerät

INKLUSIVE



eMONSTER 1/2" Brushless-Akku-Schlag-Schrauber-Satz



405,00

max. Löse-Drehmoment: 690 Nm
Antrieb: 1/2"

515.6100



eMONSTER Brushless-Akku-Winkelschleifer-Satz



450,00

Drehzahl: 9000 U/min
Vibrationsbeschleunigung: < 4,831 m/s²
3,371 m/s²

515.6200

INKLUSIVE



Akkuspannung: 18,0 V
max. Ladestrom: 8 A

Akkuspannung: 18,0 V
Akkutechnologie: Lithium-Ionen
Akkukapazität: 4,0 Ah

Lieferung inkl. zwei 4,0 Ah Akkus und 8 A Schnellladegerät



NEU

1/4" TORSIONpower Bit-Satz im eMONSTER-Akku-Design, 32-tlg

15,00

515.6932

1 x		1/4"
1 x		1/4"
4 x		3 - 4 - 5 - 6 mm
4 x		PH1 - 2 x PH2 - PH3
4 x		PZ1 - 2 x PZ2 - PZ3
4 x		3 - 4 - 5 - 6 mm
7 x		T10 - T15 - T20 - T25 - T27 - T30 - T40
7 x		TB10 - TB15 - TB20 - TB25 - TB27 - TB30 - TB40



+30%

lässt sich an die 18V eMONSTER Geräte als Akku-Dummy anstecken und arretieren

HIER GEHT'S SCHLAG AUF SCHLAG!

1.390 N·m

1/2"

90 mm

165 mm

515.1150

1  **300,00**

1.390 N·m

1/2"

95 mm

190 mm

515.1270

2  **225,00**

1.084 N·m

1/2"

115 mm

180 mm

515.1315

3  **105,00**

1.600 N·m

1/2"

170 mm

188 mm

515.1200

4  **105,00**

2.000 N·m

3/4"

170 mm

185 mm

515.3400

5  **188,00**

1.690 N·m

1/2" 3/4"

175 mm

200 mm

515.1210

6  **225,00**

7  **285,00**

3.405 N·m

3/4" 1"

40 mm

350 mm

515.3250

9  **1275,00**

11  **1275,00**

3.405 N·m

3/4" 1"

195 mm

350 mm

515.3260

10  **1358,00**

12  **1358,00**

													
		Nm	U/min	m/s ²	dB(A)	dB(A)	U/min	PT					Kg
1	515.1150	1/2"	1390	10.000	<9,18	102,0	113,0	135	1/4"	-	✓	-	1,08
2	515.1270	1/2"	1390	10.000	<9,18	102,0	113,0	135	1/4"	-	✓	✓	1,3
3	515.1315	1/2"	1084	9000	<10,36	106,0	115,0	169	1/4"	-	✓	✓	1,2
4	515.1200	1/2"	1600	8500	<17,5	89,9	100,9	169	1/4"	✓	✓	-	2,1
5	515.3400	3/4"	2000	8500	<17,25	91,0	100,9	196	1/4"	✓	✓	-	2,2
6	515.1210	1/2"	1690	7930	<17,9	87,0	98,0	178	1/4"	✓	✓	-	2,1
7	515.3785	3/4"	1690	7930	<13,56	88,0	104,0	178	1/4"	✓	✓	-	2,2
8	512.0002	1/2"	2300	8500	<8,69	99,7	110,9	244	1/4"	✓	✓	✓	1,6
9	515.3250	3/4"	3405	6200	<12,57	115,5	104,5	283	1/2"	✓	✓	-	6,7
10	515.3260	3/4"	3405	6200	<12,88	115,5	104,5	283	1/2"	✓	✓	-	7,7
11	515.3270	1"	3405	6200	<12,57	115,5	104,5	283	1/2"	✓	✓	-	6,7
12	515.3280	1"	3405	6200	<12,88	115,5	104,5	283	1/2"	✓	✓	-	7,8

i **1**
Weitere Informationen

Fettförderung: Je ein Hub pro Abzugsbetätigung

200 mm
400 g
400 mm

100,00

515.3900 Druckluft-Fettpresse für hubweise Fettförderung

i **1**
Weitere Informationen

ab 38,00

PU ✓

515.3330	6,0 mm	G1/4" AG	8,0 m	38,00 CHF
515.3335	8,0 mm	G1/4" AG	15,0 m	53,00 CHF
515.3340	10,0 mm	G3/8" AG	15,0 m	60,00 CHF

515.3340

i **1**
Weitere Informationen

15,00

regulierbar

100 mm

515.1901 Druckluft-Ausblaspistole mit Durchflussregulierung

i **3**
Weitere Informationen

30,00

510 mm
330 mm
95 mm

515.1921 Druckluft-Ausblaspistolen-Satz

Automatischer Druckluftschlauch-Aufröller

15 m
1,5 m

180°

STOP

i **1**
Weitere Informationen

180,00

Ø 10 MM X 15 M

A

Technische Daten:
Schlauchinnendurchmesser: 10,0 mm
max. Druck: 20,0 bar
Anschlussgewinde: 1/4"

515.3440

i **1**
Weitere Informationen

270,00

Ø 13 MM X 15 M

B

Technische Daten:
Schlauchinnendurchmesser: 13,0 mm
max. Druck: 20,0 bar
Anschlussgewinde: 3/8"

515.3445

i **1**
Weitere Informationen

A 480 mm
320 mm
36 mm

B 1.150 mm
320 mm
36 mm

ab
18,00

A	500.8040	480 mm	18,00 CHF
B	500.8045	1.150 mm	60,00 CHF

i **1**
Weitere Informationen

1

75,00

500.8020

i **1**
Weitere Informationen

2

90,00

500.8030

i **1**
Weitere Informationen

HOCHBELASTBAR MIT 135 KG

3

105,00

500.8004

i **1**
Weitere Informationen

4

105,00

500.8011

i **1**
Weitere Informationen

6

150,00

500.8000

	1	2	3	4	5	6
Technische Daten:	500.8020	500.8030	500.8004	500.8011	500.8090	500.8000
Farbe	rot	rot	rot	rot	rot	rot
Material	Stahlrohr	Metall	Metall	Metall	Kunststoff	Metall
Anzahl Lenkrollen	4	5	5	6	6	6
rollbar	✓	✓	✓	✓	✓	✓
Art der Bereifung	Kunststoff	Kunststoff	Gummi	Kunststoff	Kunststoff	Kunststoff
gepolstert	✓	✓	✓	✓	✗	✓
höhenverstellbar	✗	✓	✓	✓	✗	✓
Verpackungsinhalt	1	1	1	1	1	1
Gesamtlänge L in mm	365,0 mm	370,0 mm	360,0 mm	1040,0 mm	1030,0 mm	1200,0 mm
Breite B	360,0 mm	370,0 mm	360,0 mm	490,0 mm	480,0 mm	420,0 mm
Höhe H	360,0 mm	420,0 - 540,0 mm	463,0 - 580,0 mm	85,0 - 400,0 mm	115,0 mm	145,0 - 510,0 mm
Gesamttragkraft kg	90 kg	90 kg	135 kg	90 kg	120 kg	90 kg

i **1**
Weitere Informationen

DIE LEICHTESTE

5

102,00

500.8090

i **3**
Weitere Informationen

Genial flexibel

1 **53 x 29,5 x 3,2 cm**

2 **25,5 x 23,3 x 2,4 cm**

3 **27,5 x 14,5 x 2,4 cm**

NEU

68,00

500.8077 Werkzeugablagensatz aus Silikon

i **1**
Weitere Informationen

- mit rutschfestem Profil auf der Laufbühne
- mit großer Plattform für sicheren Stand
- Kunststoffkanten an Füßen schützen Laufbühne und den Boden

150,00

Aluminium-Sicherheits-Laufbühne

800.0960

FÜR IHRE SICHERHEIT



GEPRÜFT!

i **1**
Weitere Informationen

- mit Riffelblech-Profil auf der Trittstufe
- kein Kippen durch schräg gestellte Standfüße
- zusammenklappbar und dadurch platzsparend zu verstauen

83,00

Aluminium-Stufen-Stehleiter

800.0965

MAXIMALE ARBEITSFLÄCHE

1800,00

XXL

840 mm

2000 mm

680 mm

865.0201 **XXL-Werkbank mit 3 Schubladen und 1 Tür**

KLEIN UND GROSS ZUGLEICH!

270,00

257 - 1380 mm

845 - 1320 mm

257 - 1380 mm

500.8100 **Universal Teleskop-Mehrzweckwagen mit Rollen**

NEU

180°

0 440 mm

3 5000 rpm, 57 dB, 4,9 m/s, 56,9 W

2 4500 rpm, 51,5 dB, 4,3 m/s, 53 W

1 4000 rpm, 48 dB, 3,5 m/s, 49 W

75,00

610 mm

570 mm

**EXTREM LEISE
ULTRALEICHT
< 3,5 KG**

999.2000 **Werkstattventilator, 70 Watt**

Parallel-Schraubstock

ab 249,00

360° mit Drehteller

360°

Backen und Amboss induktiv gehärtet

914.0004	120 mm	4"	249,00 CHF
914.0005	140 mm	5"	269,00 CHF
914.0006	160 mm	6"	285,00 CHF
914.0008	200 mm	8"	345,00 CHF

i

Weitere Informationen

max. 8 bar (116 PSI)	60° C 140° F

1

Water
Max. 40° C
Max.

2

Detergent

3

4

5

Switch

Lock

30,00

150.8271 Druck-Pump-Schaum-Sprüher (Schäumer)

i

Weitere Informationen

350 mm

650 mm

PEB

128,00

500.8013 Fahrbarer Hocker

i

Weitere Informationen

6,3 bar	96 L/min
92 dbA	1/4" PT

60,00

145 mm

3/8" - Ø 10 mm

saugen

pusten

515.5090 Druckluft-Saug-Blaspistole

i **1**
Weitere Informationen

Ø 90 mm

M8

9,00

515.1243 **Folienradierer**

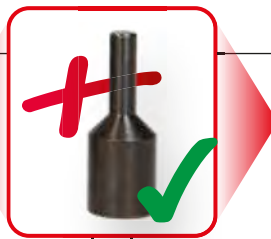

i **1**
Weitere Informationen

24 mm

Ø 100 mm

M8

24,00

515.1247 **Folienradierer mit Lamellen**

i **6**
Weitere Informationen

SETPREIS = 6x

45,00

515.1285



i **6**
Weitere Informationen

SETPREIS = 6x

135,00

515.1366

i **1**
Weitere Informationen

ON - OFF

regulierbar

Industriekugellager

213,00

515.1980 **Druckluft-Reinigungs-Pistole**

		<3.90 m/s² icon"/>

OPTIONAL

i **1**
Weitere Informationen

9,00

515.1983 **Bürsten-Aufsatz**

i **1**
Weitere Informationen

9,00

515.1986 **Bürsten-Pinsel**

i **6**
Weitere Informationen

45,00

510 mm

4 mm
8 mm
10 mm

4 mm
8 mm
10 mm

245 mm

140.2370 Clip-Löse-Satz

i **11**
Weitere Informationen

30,00

180 mm 200 mm 200 mm 200 mm 210 mm

160 mm 200 mm 200 mm 180 mm 200 mm 200 mm

911.8205 MASTER Kunststoffkeil-Satz

i **1**
Weitere Informationen

DC 12V 24V AC 100-240V 50/60 Hz

- beseitigt Gerüche und desinfiziert den Fahrzeuginnenraum
- automatische Abschaltung im Geruchsbehebungs-Modus nach 60 Minuten
- arbeitet ohne chemische Zusätze, daher ist eine rückstandslose Reinigung garantiert
- hinterlässt selbst auf empfindlichen Oberflächen keine Spuren
- beseitigt Schimmel, Bakterien, Pilze und Milben

173 mm

49 mm

122 mm

550.1183 Plasma-Luftreiniger mit Ionisator-Technik

120,00

i **1**
Weitere Informationen

- ideal geeignet zum Reinigen von engen Röhren, Schläuchen oder Abflüssen
- doppelseitig verwendbar
- flexibler Edelstahlschaft
- Nylonborsten

6,00 NEU

Ø 16 mm

Ø 22 mm

150.1762 Flexible Reinigungsbürste

i **7**
Weitere Informationen

Ø 0 - 38 mm

Ø 0 - 48,5 mm

Ø 0 - 65 mm

Ø 0 - 30 mm

Ø 0 - 45 mm

Ø 0 - 45 mm

Ø 0 - 60 mm

120,00

115.1055 KFZ Schlauchschellenzangen-Satz

i **3**
Weitere Informationen

15,00

Ø 15 mm Ø 30 mm Ø 60 mm

150 mm 180 mm 250 mm

115.5050

i **3**
Weitere Informationen

Ø 15 mm Ø 35 mm Ø 23 mm

155 mm 255 mm 165 mm

20,00

115.5055

i **1**
Weitere Informationen

23,00

Absaug- und Füllhandpumpe

150.9221

i **1**
Weitere Informationen

30,00

3/8" Spezial-Steckschlüssel für Saugrohr-Verschraubungen

100 mm

150.2519

i **1**
Weitere Informationen

30,00

12V 5A 60W
Richtung Direction
150.2620

Elektrische Öl-Absaug- und Umfüllpumpe

150.2620

i **1**
Weitere Informationen

8,00

NEU

Wechselnuss für 30-45 mm und 60-80 mm Schlauchschellen

30 mm

2 in 1 Spezial-Steckschlüssel für Schlauchschellen mit 3-Punkt-Profil

115.0915

i **1**
Weitere Informationen

20,00

NEU

Kühlerdeckel-Lösewerkzeug für VAG

150.1919

1/2" 108 mm





25

Weitere Informationen







0 - 2,5 bar



max. 76 cm



0 - 200 °C
0 - 400 °F



1600 mm



R123
R124



R123
R125



#1



#2



#3



M50 x 2,5



M42 x 3



M58 x 3



M62 x 3



M48 x 4



M45 x 3



M50 x 2,5



M60 x 4



M52 x 3



M48 x 2,5



M42 x 2,5



M50 x 3



M46 x 3



M34 x 2,5



75 mm

270,00

MASTER

150.1930 **Kühlsystem-Diagnose-Service-Satz**







1

Weitere Informationen

Kupplung 7,2 mm auf 4,4 mm



7,2 mm



4,4 mm

30,00

150.1936







1

Weitere Informationen

Kupplung 4,4 mm auf 7,2 mm



4,4 mm



7,2 mm

38,00

150.1937



i **8**
Weitere Informationen

250 ml

150,00

OPTIONAL ZUM NACHKAUF

23,00

150.1914

150.1910 CO2-Zylinderkopf-Lecktest-Satz

i **3**
Weitere Informationen

GENIAL FLEXIBEL

53 x 29,5 x 3,2 cm

1

2 25,5 x 23,3 x 2,4 cm

3 27,5 x 14,5 x 2,4 cm

NEU

68,00

500.8077 Werkzeugablagensatz aus Silikon

i 2
Weitere Informationen

EcoBoost

NEU

180 mm + 215 mm

14 mm + 16 mm

38,00

FÜR FORD ECOBOOST MOTOREN 1,0 LITER

FÜR FORD ECOBOOST MOTOREN 1,5 LITER

517.1135 **Zündkerzen-Stecknuss-Satz für EcoBoost Motoren**

i 2
Weitere Informationen

M20 x 1.5 + M22 x 1.5

27 mm

13 mm

- zum Nachschneiden verrosteter und beschädigter Sondengewinde
- ideal für NOX- und Partikelfiltersensoren an Abgasanlagen
- mit 6 Schneiden für ideale Zentrierung
- besonders kurze Ausführung
- mit Reinigungsnuten im Führungsbolzen

mit 6 Schneiden für ideale Zentrierung

mit Reinigungsnuten im Führungsbolzen

270,00

150.2540 **Gewindeschneider-Satz mit Führungsbolzen für Sensoren**

GENIALE PROBLEMLÖSER

NEU

i 1
Weitere Informationen

Gewindeschneider mit Führungsbolzen

- zum Nachschneiden verrosteter und beschädigter Sondengewinde

L2
L1

13 mm

mit 6 Schneiden für ideale Zentrierung

mit Reinigungsnuten im Führungsbolzen

150,00

			L1	L2			
A	150.2541	für Temperatursensoren	M12 x 1,25	55 mm	33 mm	13 mm	150,00 CHF
B	150.2542	für Temperatursensoren	M14 x 1,5	45 mm	30 mm	13 mm	150,00 CHF
C	150.2543	für Lambdasonden	M18 x 1,5	42 mm	27 mm	13 mm	150,00 CHF
D	150.2544	für NOX-Sensoren	M20 x 1,5	50 mm	27 mm	13 mm	150,00 CHF
E	150.2546	für Partikelfiltersensoren	M22 x 1,5	50 mm	27 mm	13 mm	150,00 CHF

i  **1**
 Weitere Informationen

30,00



1 **2**

500.7505 Zündspulen-Abzieher für Stab-Zündspulen



i  **7**
 Weitere Informationen

FÜR VAG UND OPEL MOTOREN

105,00



1 **2** **3** **4** **5** **6** **7**

500.7570 T-Griff-Zündspulen-Abzieher-Satz für VAG und Opel Motoren



i  **7**
 Weitere Informationen

120 ml 120 ml



6x10
6x6
6x8
6x4
600 mm
Ø 6x9 mm

255,00

150.1900 Druck- und Unterdruck-pumpen-Satz



i  **24**
 Weitere Informationen



75,00

700.1280 Universal Wellendichtring und Simerring Montagewerkzeug-Satz



i **1**
Weitere Informationen

max. 165 mm

60,00

M 12 x 75 mm

3/8" 17 mm

30 mm

40-165 mm

Universal-Rillen-Riemenscheiben-Abzieher Ø 40-165 mm

150.3170

i **1**
Weitere Informationen

NEU

1/4" 13 mm

Ø 3,0 mm

- zum Spannen und Entspannen der Zahnriemen-Spannrolle
- verstellbar, universal einsetzbar
- Innenvierkantantrieb nach DIN 3120 / ISO 1174
- mit Außensechskantantrieb 13,0 mm
- phosphatiert

8 - 25 mm

30,00

Universal-Zapfenschlüssel für Zahnriemen-Spannrolle, verstellbar

150.3046

i **1**
Weitere Informationen

Anwendungsgebiete: Citroën, Peugeot, Opel und Toyota mit 1,0 und 1,2 Benzin-Motoren (Motorcode: ZMZ (EB0F / EB0) / HMO1 (1PP) / HMV, HMZ (EB2) / HMZ (EB2 / EB2F) / HMT (EB2D) / HMU (EB2D) / HNZ (EB2DT) / HNY (EB2DTS) / HMV (EB2M) / HMY (EB2M) / B12XE (EB2F) / D12XE (EB2FA) / B12XHL (EB2DT) / D12XHL, F12XHL (EB2ADT) / B12XHT (EB2DTS) / D12XHT, F12XHT (EB2ADTS))

15,00

Zahnriemen-Prüfwerkzeug für PSA

400.2118

i **1**
Weitere Informationen

M 15 x 1,5 x 71 mm

17 mm

27 mm

70 mm

53,00

Universal-Riemenscheiben-Abzieher 3-armig

150.3130

i **22**
Weitere Informationen

- für die Montage und Demontage der schwer zu öffnenden CLIC-Federverschluß-Leitungskuppungen bei Kraftstoff-, Klimaanlage-, Luft- und Hydraulikleitungen
- keine Beschädigung der Steckkupplungen, Kraftstoffleitungen und Kraftstoffschläuche
- schnelles und einfaches Trennen der Kraftstoffleitungen
- für nahezu alle Leitungskuppungen an CHFopäischen, asiatischen und amerikanischen Fahrzeugen

115.1260 Leitungverbinder-Entrieglungs-Satz

75,00

5/16" 1/4" 5/16" 3/8" 3/8" 1/2" 5/8" 7/8"

3/8" 1/2" 5/8" 3/4" 5/16"

3/8" 1/2" 5/8"

3/4" 7/8" 5/16" x 3/8"

5/16"



Weitere Informationen

MIT 3.873 SCHLÄGEN PRO MINUTE ZIEHT ER JEDEN AUS!

- inklusive 7 Adaptern für nahezu alle Injektoren
- enorm hohe Schlagwirkung (3365 (6,3 bar) / 3873 (8 bar) Schläge pro Minute)
- zum Ausbau der festgebrannten Injektoren im Zylinderkopf
- mit einem entsprechenden Adapter wird der Auszieher an der festsitzenden Einspritzdüse verschraubt
- geringer Platzbedarf durch kompakte Bauweise



223 L/min	3/4"-19 mm	108,4 dbA
6,3 bar (90 psi)	71,9 m/s²	6 mm
12 bar	119,4 dbA	M18 x 1,5

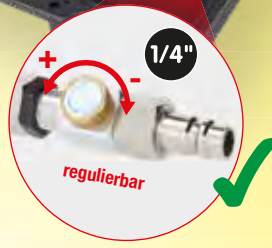
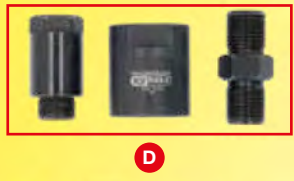

A	M25 x 1,0	Siemens
B	M20 x 1,0	Denso
C	M27 x 1,0	Siemens
D	M27/M17/10 mm	Bosch/Fiat/BMW/PSA/ Mercedes/Renault
E	M18 x 1,5	Adapter
F	M17 x 1,0	Bosch/Mercedes
G	M16 x 1,0	Toyota
H	M14 x 1,5	Bosch/Delphi/BMW



BOSCH ✓
DENSO ✓
DELPHI ✓
SIEMENS ✓
 ... ✓

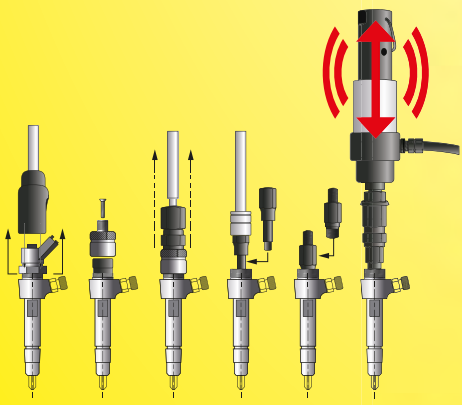

405,00

152.1130 Druckluft Injektoren-Auszieher-Satz

Alle Preise in CHF zzgl. MwSt. gelten bis 30.09.2024

6
Weitere Informationen

285 - 875 mm
TELESKOPIERBAR
150 - 675 mm

500g
200g
1000g
2000g
3000g

Ø 4 mm
Ø 13 mm
Ø 16 mm
Ø 19 mm

400 mm
510 mm

NEU

41,00

550.1090 **Flexibler und teleskopierbarer Magnethalter und Inspektionsspiegel-Satz**

1
Weitere Informationen

125 mm

6 - 24 V
8,00

550.1504 **Prüflampe 6 - 24 V**

1
Weitere Informationen

18,00

3 - 48 V

550.1503 **Polaritäts- und Spannungsprüfer 3 - 48 V**

2
Weitere Informationen

195,00

25 m

6 - 24 V

150.1655 **Funktionsprüflampe**

2
Weitere Informationen

1 Empfänger
2 Sender mit Krokodilklemmen

90,00

150.3075 **Gleichstrom-Kurzschlussdetektor**





Weitere Informationen





555,⁰⁰



 **Batterie laden**
 **Erhaltungsladen**
 **Reparatur der Batterie**
 **Gleichstromversorgung**

12V ● 24V ●

umschaltbar zwischen 12 und 24 Volt

550.1745 12V + 24V SMARTcharger Hochfrequenz-Batterieladegerät 25A/12,5A

Technische Daten:

Batteriekapazität:	12V: 75-500Ah - 24V: 45-250Ah
Spannungsbereich:	220-240V AC, 50/60HZ
Ladespannung:	14,4V - 25A (12V), 28,8V - 12,5A (24V)
Frequenzbereich:	50 Hz
Leitung:	H05RN-F 2x1,0 mm ²







Weitere Informationen





552,⁰⁰





550.1649 12V / 24V Digital-Batterie- und Ladesystemtester mit integriertem Drucker

Technische Daten:

Anzeige:	digital
Arbeitsbereich CA / MCA:	40-2.000 CCA
Arbeitsbereich CCA:	40-2.000 CCA
Arbeitsbereich DIN:	40-2.000 CCA
Arbeitsbereich EN:	40-2.000 CCA
Arbeitsbereich IEC:	40-2.000 CCA
Arbeitsbereich JIS#:	40-2.000 CCA
Arbeitsbereich SAE:	40-2.000 CCA
Arbeitstemperatur:	0°C bis +55°C
Frequenzbereich:	100 Hz
Messbereich:	9-36 V
Messgenauigkeit:	+/- 0,5 Megaohm
Spannungsbereich:	9-36 V

Für fast alle Batterien

Mit Drucker und 3 Rollen Papier









Weitere Informationen





900,⁰⁰





550.1720 12V + 24V Batterie-Booster - mobiles Starthilfegerät 1400 A

1.400 A

Intelligentes Sicherheitskonzept vermeidet Anwender-Fehler:

Sicherheits-schaltung gibt erst Strom auf die Klemmen wenn:

- korrekt angeschlossen wurde (Polung)
- die Verbindung kurzschlussicher ist
- die richtige Spannung anliegt
- die Fahrzeugbatterie in Ordnung ist



i **26**
Weitere Informationen

DVE GS
1000 V

3/8"

495,00

Werkzeugsatz mit isolierten Werkzeugen für Hybrid- und Elektrofahrzeuge

117.1895

2 x		4 mm - 5,5 mm
2 x		PH1 - PH2
6 x		6 - 8 - 10 - 12 - 13 - 17 mm
1 x		185 mm
1 x		165 mm
1 x		3/8"
1 x		3/8": 200 mm
1 x		3/8": 125 mm
10 x		3/8": 8 - 10 - 11 - 12 - 13 - 14 - 16 - 17 - 19 - 22 mm
1 x		200 mm

i **43**
Weitere Informationen

DVE GS
1000 V

3/8"

848,00

Isolierter Werkzeug-Satz für Hybrid- und Elektrofahrzeuge

117.1890

4 x		2,5 - 3 - 3,5 - 4 mm
3 x		PH1 - PH2 - PH3
3 x		T20 - T25 - T30
1 x		210 mm
1 x		185 mm
1 x		165 mm
1 x		215 mm
1 x		165 mm
1 x		240 mm
2 x		10 - 25 mm
1 x		180 mm
1 x		3/8"
15 x		3/8": 6 - 7 - 8 - 9 - 10 - 11 - 12 - 13 - 14 - 16 - 17 - 18 - 19 - 20 - 22 mm
2 x		3/8": 150 - 250 mm
3 x		3/8": M8 - M10 - M12
1 x		Ø 200 mm
1 x		200 mm
1 x		500 m

i **18**
Weitere Informationen

DVE GS
1000 V

495,00

Maulschlüssel-Satz mit Schutzisolierung

118.1500

18 x		7 - 8 - 9 - 10 - 11 - 12 - 13 - 14 - 15 - 16 - 17 - 18 - 19 - 20 - 21 - 22 - 23 - 24 mm
------	--	---

i **1**
Weitere Informationen

<44.500 V

270,00

Isolierte Rettungsstange

150.0913

1.680 mm

DER EINSTEIGER-SATZ IN DIE ELEKTROMOBILITÄT

ecoline



1

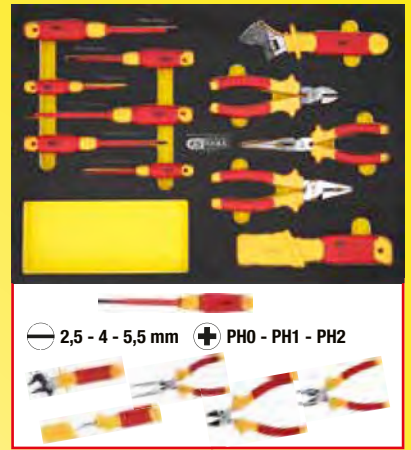

2

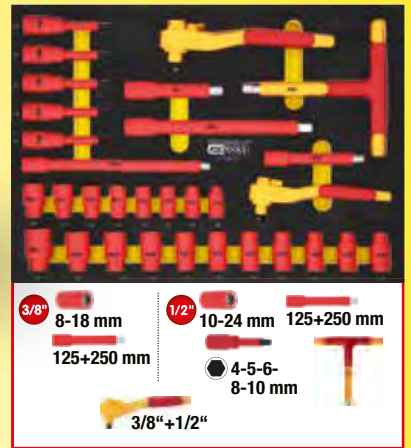

Vierkantlochung für Zubehörteile

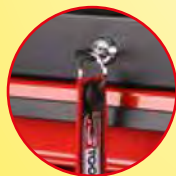

verschießbar durch eingebautes Zylinderschloss



Arbeitsplatte mit 10 mm starker Schaumstoffeinlage



mit Selbsteinzug und SOFT-CLOSE-Funktion



2 x Roll- und Drehbremsen Ø Räder: 125 mm

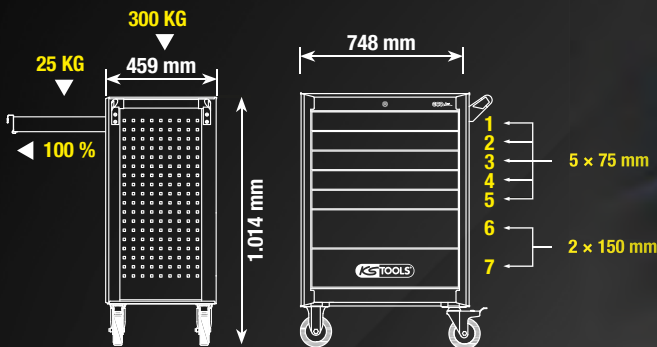

ECOline Werkstattwagen mit 42 isolierten Werkzeugen für Hybrid- und Elektrofahrzeuge

1949,00 
INKLUSIVE 42 WERKZEUGE

117.6144



6449,00



117.6172 3/8"+1/2" Isolierter Steckschlüssel-Satz mit Drehmomentschlüssel in Schaumstoffeinlage, 72-tlg



117.6133 Isolierte Schlüssel-Satz in Schaumstoffeinlage, 33-tlg

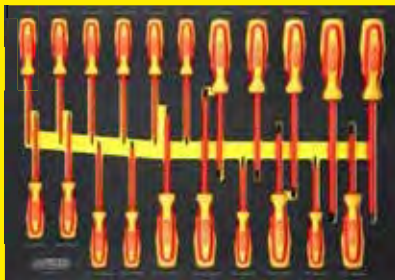

117.6121 ERGOTORQUE VDE Schraubendreher-Satz in Schaumstoffeinlage, 21-tlg



117.6117 ERGOTORQUE VDE Zangen-Satz in Schaumstoffeinlage, 17-tlg



917.3898

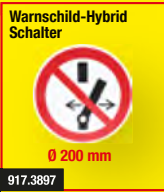

917.3897



117.3819



117.1660



117.1664



117.1796

117.6155 PERFORMANCEplus Werkstattwagen e10 mit 164 isolierten Werkzeugen für Hybrid- und Elektrofahrzeuge

DER UMFANGREICHSTE SEINER KLASSE

15,00



117.0223 Dachaufsteller mit Blitzsymbol und Magnet



15,00

117.0222

Dachaufsteller mit
Blitzsymbol und Saugnapf



23,00

117.0226

Aufsteller mit Blitzsymbol



105,00

117.1550

Absperrpfosten-Satz
mit Kette

2x

210,00

117.1545

2 x Scherensperre aus
Kunststoff



Den Elektromobilitäts-Katalog
mit 188 Seiten finden Sie unter
www.kstools.com

i  **4**
Weitere Informationen

Ø 22,0 - 28,0 mm

Ø 15,0 - 21,0 mm

Ø 17,0 - 25,0 mm

Kupplungs-Zentrier-Werkzeug-Satz

14,00

150.2180 Ø 15,0 - 28,0 mm



i  **11**
Weitere Informationen

150 kg

310 mm

450 mm

593,00

300 mm

160.0910 **Universal-Getriebehalter-Satz**



i  **3**
Weitere Informationen

- 1 Füllwerkzeug A montieren und demontieren
- 2 Öl ablassen, geringer Durchfluss
- 3 Füllstand überprüfen
- 4 Öl ablassen, voller Durchfluss

38,00

9G-TRONIC

56 mm

20 mm

74,5 mm

9 mm

28,5 mm

39,5 mm

9 mm

152 mm

48 mm

150.9695



160.0910 **Universal-Getriebehalter-Satz**



i  **24**
Weitere Informationen

DER UMFANGREICHSTE!

300,00

INKLUSIVE 23-TLG ADAPTERSATZ

150.9261		1/8-27 NPT Ford
150.9262		BMW, Honda, Nissan etc.
150.9263		VAG
150.9264		VAG, Porsche
150.9265		M10 x 1.0 VAG, Mini Cooper
150.9267		M12 x 1.5 Mercedes
150.9268		M24 x 1.5 VAG DSG
150.9269		M22 x 1.5 VAG CVT
150.9271		M18 x 1.5 Skoda
150.9272		M30 x 1.5 VAG, Skoda
150.9273		Universal Flexible 300 mm, Honda, Hyundai, Kia, etc.
150.9274		5/16-24 (UNF) Volvo
150.9276		M18 x 1,5 Toyota / Lexus
150.9277		M8 x 1,0 Nissan / Infinity
150.9278		ATF-Adapter V.W, Passat
150.9562		Nissan Juke M12 x 1,25
150.9563		Mini Cooper M14 x 1,5
150.9564		issan M10 x 1,5
150.9566		GM M12 x 1,75
150.9567		Mercedes 725-9G
150.9102		VAG 7 DSG
150.9103		VAG 7 DSG
150.9104		VAG 7 DSG

NEU!

150.9105 **Universal Getriebeöl-Füllsystem-Satz inkl. 23-tlg Adaptersatz**



i  **4**
 Weitere Informationen



168,00



Ø 30 mm

McPherson Federbeinstütze für Getriebeheber

160.0195

i  **7**
 Weitere Informationen



6 mm

150,00





Spezial Stoßdämpfer-Montagehilfe-Satz für Stoßdämpfer mit Zuganschlagfeder

150.9545

FÜR IHRE SICHERHEIT  **GEPRÜFT!**

i  **6**
 Weitere Informationen

universal für 90% aller gängigen Fahrzeugfedern im PKW und Transporterbereich



Ø 80 - 160 mm

Ø 140 - 195 mm

BELASTUNG max 26000 N

678,00

- ideal geeignet zur sicheren Montage und Demontage von Mc Pherson Federbeinen
- erforderlich beim Stoßdämpfer- oder Schraubenfederwechsel
- universal für 90% aller gängigen Fahrzeugfedern im PKW und Transporterbereich
- kostengünstige und solide Alternative zu gängigen Federspanner
- auch für konische - und Kugelfedern geeignet
- mit TÜV-Zulassung

500.8400 Universal Federspanner-Satz

Technische Daten:	
Federdruck max.:	2600 kg
Spannweite max.:	355,0
Federkapazität:	80,0 - 195,0 mm

FÜR IHRE SICHERHEIT



GEPRÜFT!

i **11**
Weitere Informationen

TUV SUD

1/2" x 1/2", 100 Nm

Ø 30 mm

Ø 90 - 140 mm

560,00

500.8765 Audi und Seat Teleskop-Centerspanner-Satz für innenliegende Federn

ZUR ERWEITERUNG

i **2**
Weitere Informationen

Ø 95-110 mm

150,00

FÜR FEDERSPANNER
500.8755 + 500.8765

Anwendungsgebiete:
Mercedes E-Klasse (W211 / W212), C-Klasse (W204), GLA (X156), GLK (X204),
Ford Focus II (MK2), BMW 1er (E81), Volkswagen Passat (B8 / 3G)

500.8770 Paar-Federhalter Ø 95-110 mm

ZUR ERWEITERUNG

i **9**
Weitere Informationen

TUV SUD

Ø 30 mm

Ø 90 - 140 mm

Ø 75 - 115 mm

509,00

WARNING - ACHTUNG - ADVARSEL
ADVERTENCIA - AVERTISSEMENT

500.8755 Universal Teleskop-Centerspanner-Satz für innenliegende Federn

FÜR 95% ALLER FAHRZEUGE



Weitere Informationen



max
12000
N

1724,00

Druckluft-Stand-Federspanner,
max. 10 bar

500.8800



Weitere Informationen



max
24000
N

2399,00

Druckluft-Stand-Federspanner
mit Doppel-Zylinder

500.8810



Weitere Informationen

- einfache Handhabung
- Spezial-Werkzeugstahl
- ideal zur Aufnahme von Federbeinen
- optimal für sicheren Stand bei der Montage und Demontage
- mit 4 Fixierbolzen und 4 Gewindebolzen
- Lieferung erfolgt mit 2 Sprengringen zur Montage

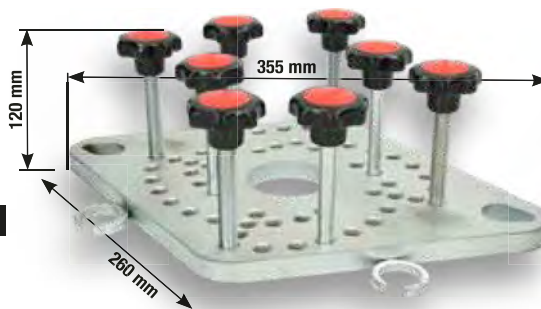

423,00



500.8801

Adapterplatte für Druckluft-Stand-Federspanner

FEDERSPANNER-SATZ INKLUSIVE ADAPTERPLATTE



Weitere Informationen

Druckluft-Stand-Federspanner
inkl. Adapterplatte

2024,00

500.8805



Weitere Informationen

Druckluft-Stand-Federspanner
mit Doppel-Zylinder
inkl. Adapterplatte

2699,00

500.8815

MODULO 2 **ORDNUNG IST DAS**

KONFIGURIEREN SIE NACH IHREN WÜNSCHEN



440.9051



1800,00



GRÖßER ALS MAN DENKT

BREMSE



440.9087



3750,00

SILENTLAGER



440.9025



HYDRAULIKZYLINDER OHNE BETÄTIGUNGSWERKZEUGE



440.9161



5100,00

KOMPAKT-RADLAGER



440.9026

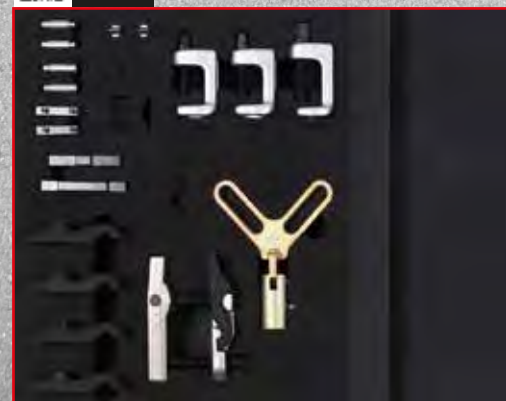

ACHSE



HALBE LEBEN

MODULO 2



P40

EDELSTAHL
ROSTFREI

www.kstools.com

KS TOOLS

Ø 155 mm

1.701 mm

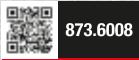

873.6008

PERFORMANCEplus P40 SCHWARZ/ROT
Werkstattwagen mit 4 Schubladen

OHNE WERKZEUGE

4141,00



Weitere Informationen





4



2200 mm

+

1350,00

Hydraulik-Pumpen-Satz
mit Ablage für P40



440.9004

1500,00



440.9076



RADLAGER



3000,00



1200,00



440.9061



STOSSDÄMPFER



2850,00



i 1
Weitere Informationen

150,00

max. 8 bar

450 mm

1/4" PT

für Universal Achsmanschetten

515.3100 Druckluftmontagegerät für Achsmanschetten

i 1
Weitere Informationen

100 mm

Ø 30 mm

255 mm

75,00

150.1850 Universal Gelenkwellen-Abzieher

i 1
Weitere Informationen

VA FE

0 - 45 mm

270 mm

60,00

115.1056 Schlauchklemmzange für Drehmomentanzug

i 1
Weitere Informationen

max. 12 mm

75,00

115.1590 Spannzange für Edelstahl-Kabelbinder mit Kugerverschluss

ab 39,00

Edelstahl-Kabelbinder mit Kugerverschluss

200 - 350 mm

115.1591		100	4,6 × 200 mm	39,00 CHF
115.1592		100	4,6 × 250 mm	39,00 CHF
115.1593		100	4,6 × 350 mm	44,00 CHF
115.1594		100	4,6 × 500 mm	57,00 CHF

i 1
Weitere Informationen

10 mm

UNIVERSAL

60,00

700.5662 Klemmbohrungs-Spreizwerkzeug

i **1**
Weitere Informationen

38,00

Spezial Tragelenkstecknuss für Mercedes

150.1721 Mercedes W167, W205, W213, W238, W253, W25

i **6**
Weitere Informationen

555,00

Vibro-Impact Druckluft-Meißelhammer-Satz

515.3880

- 110 mm
- 110 mm
- 130 mm
- 100 x 25 x 12 mm

10 mm

10 mm

10 mm

10 mm

31 x 1 sec.

VIBRO-POWER 515.3881 15280316

i **3**
Weitere Informationen

48,00

**Klemmschrauben-
Austreiber-Satz**

700.5635

10 mm

i **1**
Weitere Informationen

240,00

Vibro-Impact Lösewerkzeug für Spurstangen

150.1608

- vibrationsunterstütztes Lösen von Spurstangen, Konterverschraubungen oder Verschraubungen im Achsenbereich etc.
- durch den speziellen Vibrationsdorn wird ein Schlagimpuls auf die zu lösende Verschraubung gegeben, dabei werden Anrostungen gelöst und der Lösevorgang unterstützt
- Druckluft-Meißeladapter (10 mm) für den Einsatz mit marktüblichen Druckluft-Meißel-Schlaghammer

27 mm

290 mm

10 mm

65 mm



Weitere Informationen



254,00

700.1495 Universal-Achsheber mit Kette



- durch flexible Kette lassen sich Querlenker unterschiedlichster Bauformen ohne großen Kraftaufwand sicher niederdrücken



Weitere Informationen

183,00

- stabile Trapez-Gewindespindel
- Fußpedal zur Feinjustierung (20mm)
- der ideale Werkstatthelfer in vielen Situationen



160.0342 Teleskop-Unterstellstütze



Weitere Informationen



135,00

911.8187 Teleskop Gelenk-Rollkopf-Hebeleisen



Weitere Informationen

150,00



700.1465 Achsspielprüfer



Weitere Informationen

MIT SCHNELLVERRIEGELUNG



678,⁰⁰

1000 W

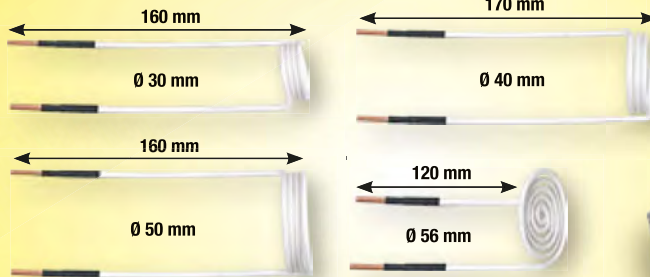

500.8605 Induktions-Heizpistolen-Satz



OPTIONAL ZUM NACHKAUF



195,⁰⁰

500.8440

2. GENERATION - 2. GENERATION - 2. GENERATION - 2. GENERATION



Weitere Informationen

HAKEN DRAN!

NEU 23,⁰⁰

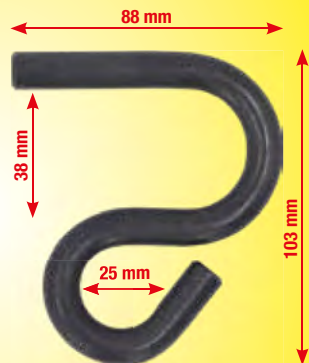
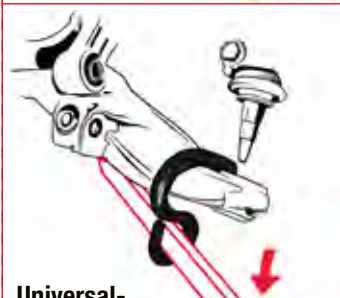
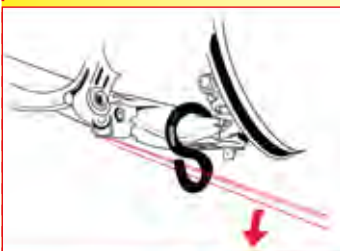

spezielle Form ermöglicht diesen sehr nah am Tragelenk anzusetzen

spezieller Hebel für die fachgerechte und schonende Montage und Demontage von Achsteilen

Universal-Achshebel-Haken

700.1499



Weitere Informationen



700.1550 Druck- und Zughülsen-Satz

450,⁰⁰



i **22**
Weitere Informationen

42 40 38 36 34
#1
32 30 28 26 24 #2
#3
M12
M10
M12 M10 TR20 #4

750,00

700.2355 **Stufen-Druckhülsen-Satz**



i **4**
Weitere Informationen

120,00

30-35 mm 35-40 mm 40-45 mm
360 mm
1/2" / 32 mm

150.1125 **Axialgelenk-Spezialschlüssel-Satz**



i **2**
Weitere Informationen

M12

NEU

115 mm 72 mm

30,00

Spezial-Kraft-Bit-Stecknuss-Satz für Vielzahn(XZN®)-Schrauben

515.0595 1/2"

i **30**
Weitere Informationen

1 x \emptyset 90 - 130 mm
1 x
4 x M 14
4 x M12 x 1,25
M12 x 1,5
M12 x 1,25
M12 x 1,5
M14 x 1,5
1 x M18 x 2,5 x 230 mm
M57 x 2

4,3 Kg

338,00

700.1530 **Universal-Radnaben- und Gelenkwellen-Abzieher-Satz**

WENIGER PERSONALEINSATZ, MEHR GEWINN.

SCHEIBE AUSTRENNEN OHNE HELFER!

140.2630

Universal Ein-Mann-Betrieb-Scheiben-Austrenngerät

- ideal für den fachgerechten und schonenden Ausbau von geklebten Windschutzscheiben sowie den meisten Heck- und Seitenscheiben
- mit großer Umlenkrolle, dadurch geringerer Kraftaufwand und Minimierung der Gefahr von Drahriss
- Drahtführung unmittelbar vor der Scheibe, dadurch entfällt in den meisten Fällen die aufwendige Demontage von Verkleidungsteilen
- leichte Bedienung durch Einmannbetrieb
- besonders hochwertige Pumpsauger für sicheren Halt auf der Scheibe



Weitere Informationen



ONE MAN CUT

NEU

Profi-Schutztafel-Satz, 4-tlg
2x 270x200 mm + 2x 450x300 mm

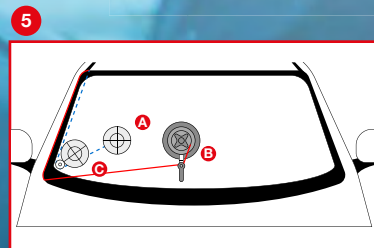
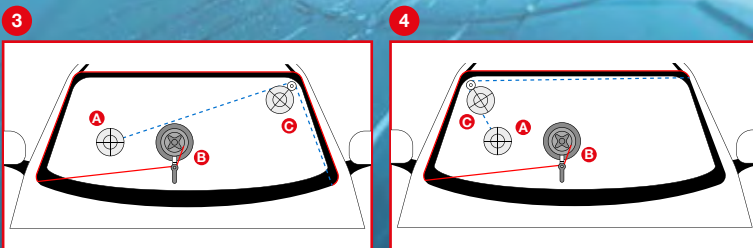
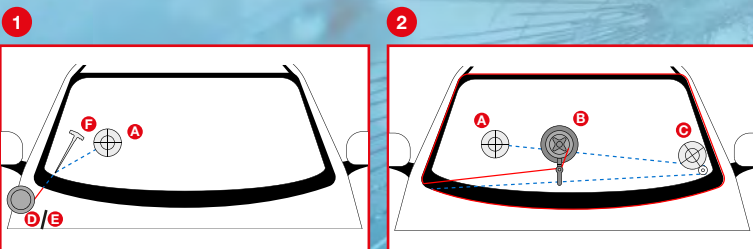

900,00

Inklusive



NEU

0 20 mm

AUCH FÜR DOT5.1, ENV4 UND ENV6

- Dot3 ✓
- Dot4 ✓

155 mm **23,00**

150.1969 Bremsflüssigkeitstester

1

42,00

150.8258 Pumpsprühflasche

Speziell für Bremsenreiniger

2

17,00

150.1935 Universal-Haken-Satz, formbar

2

23,00

150.2235 Universal-Haken-Satz, starr

12

75,00

150.2400

Bremssattelverschraubung-Spezialstecknuss-Satz

1/2" 11,5 mm 14 mm 15 mm 20 mm AS 22 mm

1/4" 9 x 20 mm

3/8" 7 x 72 mm
7 x 92 mm
9 x 50 mm
11 x 100 mm

3/8" 7 x 25 - 8 x 25 mm

41

150,00

150.1970 Bremskolben-Rückstell-Werkzeug-Satz



Weitere Informationen

DAS UNIVERSAL-GENIE



UNIVERSAL
Für 95% aller Fahrzeuge



195,00

150.2440 Universal Bremskolben-Rückstell-Werkzeug-Satz



Weitere Informationen

1050,00



5L

160.0700 Bremsenwartungsgerät KS5

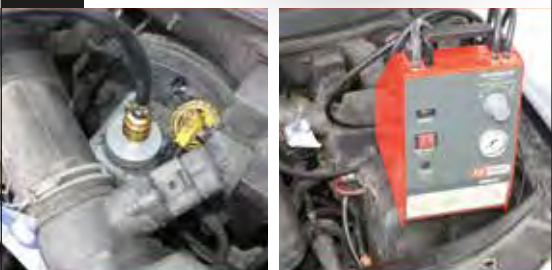

Weitere Informationen

75,00



160.0718 Universal-Entlüfterstutzen-Adapter, verstellbar



Weitere Informationen

TOYOTA & LEXUS



160.0719 Universal-Entlüfterstutzen-Adapter für Toyota und Lexus

26,00

i **6**
Weitere Informationen

105,00

160.0725 Bremsen-Entlüftungsschlüssel-Satz

1,200 mm

11 mm
10 mm
9 mm
8 mm
7 mm

i **11**
Weitere Informationen

DER KOMPLETTE

113,00

518.0320 Bremsen-Entlüftungs-Werkzeug-Satz für VAG

1,200 mm

9x12 mm

180 mm

11 mm
10 mm
7 mm
11 mm
11 mm
10 mm
11 mm
12 mm
29 mm
39 mm
45 mm
60 mm
70 mm
75 mm
85 mm

NEU

i **1**
Weitere Informationen

60,00

120.1006 Bremsleitungs-Biegewerkzeug

4,75 mm (3/16")

21 mm
31 mm
41 mm
61 mm
76 mm

i **1**
Weitere Informationen

45,00

120.1004 Bremsleitungs-Richtwerkzeug / -Biegewerkzeug

4,75 mm (3/16")
6,35 mm (1/4")

1 Biegen

2 Duplizieren

3 Richten

OUT IN

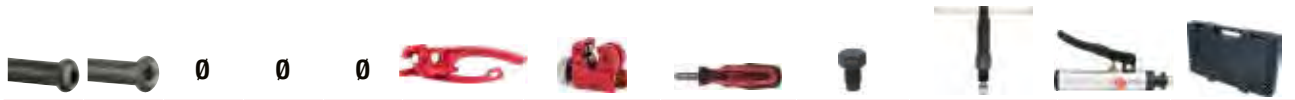

		DIN	SAE	4,75 mm	5,0 mm	6,0 mm	mit Rohrbieger	mit Rohrschneider	mit Rohrentgrater	mechanisch	mit Hydraulikspindel	Handpumpe	im Koffer
1	122.1215	✓	✗	✓	✗	✗	✗	✗	✗	✓	✗	✗	✗
2	122.1290	✓	✓	✓	✓	✓	✓	✓	✓	✗	✓	✗	✓
3	122.1260	✓	✓	✓	✓	✓	✗	✗	✗	✗	✗	✓	✓





4



Weitere Informationen



75,00

1 122.1215 **FLAREFIXeco 4,75 mm Universal-Bremsleitungs-Bördelgerät-Satz**





16

FLAREFIX

Weitere Informationen



255,00

2 122.1290 **FLAREFIX 1 Universal-Bremsleitungs-Bördelgerät-Satz mit Hydraulik-Spindel**

DIN

SAE

max. 2t

4,75(3/16")
5/8mm

3,0-12,0 mm

3,0-6,0 mm

3,0-16,0 mm

4,75-5,0 mm, SAE

4,75 mm, 3/16"

6,0 mm, SAE

4,75-5,0-6,0 mm, SAE-90°

5,0 mm

4,75-5,0 mm, DIN

6,0 mm, DIN

M12x1,25

6,0 mm





11

HYDRAULISCH, PRAKTISCH, GUT!

Weitere Informationen

FLAREFIX II

Hydraulic



DIN

SAE

max. 2,5t

4,75(3/16")
5/8mm

450,00

3 122.1260 **FLAREFIX 2 Universal-Bremsleitungs-Bördelgerät-Satz mit Hydraulik-Zylinder**

M12 x 1,25 mm

4,75-5,0 mm, SAE

6,0 mm, SAE

4,75-5,0-6,0 mm, SAE-90°

5,0 mm

4,75-5,0 mm, DIN

4,75 mm, 3/16"

6,0 mm, DIN

6,0 mm

M12x1,25

i  **9**
 Weitere Informationen



1 Ford/PSA	2 BMW	3 VAG	4 Mercedes	5 DAF/MAN
6 GM	7 Ford	8 Ford	9 Ford	

38,00

150.1040 **3/8" Öldienst-Spezialprofil-Satz für Kunststoff-Ölablassschrauben, 9-tlg**

i  **6**
 Weitere Informationen



- Werkzeug zum Planen des Dichtses von Ölablassschrauben
- Planen des Dichtses sichert einwandfreie Abdichtung im Bereich der Ölablassschraube
- exakte Zentrierung und Ausrichtung zur Dichtfläche
- Satz inklusive Adaption für Original-Ölablassschraube und Übermaß-Reparaturgewindeschraube
- in stabilem Kunststoffkoffer

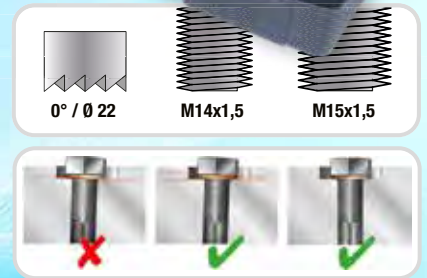

150.1485 **Ölablassschrauben-Dichtsz-Planfräser-Satz**

i  **1**
 Weitere Informationen



150.9359 **Auffangwanne 7,5 Liter**

i  **30**
 Weitere Informationen

1/2" 21 mm
 Ø 63 - 102 mm

150,00

3/8" Ölfilterschlüssel-Satz

65-14, 65/67-14, 66-6, 68-14, 73-14, 74-15, 74/76-15, 75/77-15, 76-8, 76-12, 76-14, 76-30, 78-15, 80-15, 80/82-15, 86-18, 86-16, 90-15, 92-10, 93-15, 93-36, 93-45, 95-15, 96-18, 100-15, 106-15, 108-15, 108-18



i  **24**
 Weitere Informationen

2,0 L

150,00

MASTER ÖI-Einfülltrichter-Satz mit drehbarem Winkelarm

VW, Lexus, Lotus, Ford, Nissan
 Subaru, Mitsubishi, Land Rover, Hyundai, Audi
 Chrysler, Toyota, Citroën, Volvo, Cadillac
 Citroën, Buick, Volvo, Buick, universal



i  **4**
 Weitere Informationen

FÜR VAG

mit drehbarem Winkelarm für schwer zugängliche Stellen

23,00

ÖI-Einfülltrichter-Satz mit drehbarem Winkelarm für VAG

2,0 L



AUF DIE BÜHNE - FERTIG - LOS!

aus Voll-Gummi



NEU

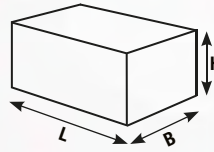

i **1**
Weitere Informationen

Teile	L mm	B mm	H mm		
160.0476	1	160	120	20	8, ⁰⁰ CHF
160.0477	1	160	120	30	11, ⁰⁰ CHF
160.0478	1	160	120	40	14, ⁰⁰ CHF
160.0479	1	160	120	60	20, ⁰⁰ CHF
160.0480	1	160	120	80	26, ⁰⁰ CHF
160.0481	1	160	120	100	32, ⁰⁰ CHF
160.0482	1	160	120	115	36, ⁰⁰ CHF
160.0483	1	116,5	116,5	36,5	9, ⁰⁰ CHF
160.0499	1	160	120	85	27, ⁰⁰ CHF

PE (Polyethylen)

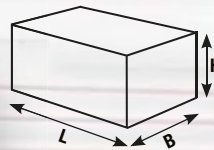

NEU

i **1**
Weitere Informationen

Teile	L mm	B mm	H mm		
160.0437	1	250	150	55	23, ⁰⁰ CHF
160.0438	1	250	150	100	41, ⁰⁰ CHF
160.0486	1	340	150	55	30, ⁰⁰ CHF
160.0489	1	340	130	100	48, ⁰⁰ CHF

i **1**
Weitere Informationen

aus Voll-Gummi mit verstärktem Kern



NEU

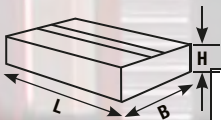

Teile	L mm	B mm	H mm		
160.0484	1	373	100	35	60, ⁰⁰ CHF

i **4**
Weitere Informationen

aus hochfestem Kunststoff



NEU

- Model 3 ✓
- Model S ✓
- Model X ✓
- Model Y ✓

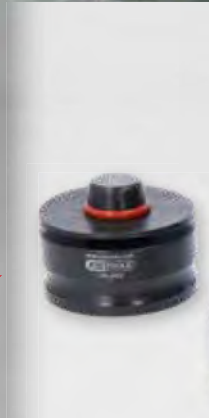

160.0460 Tesla Model 3, S, X, Y

36,⁰⁰

i **4**
Weitere Informationen

aus Voll-Gummi

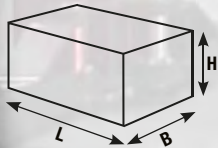

Teile	L mm	B mm	H mm		
160.0391-TD	4	155	125	35	53, ⁰⁰ CHF

i **1**
Weitere Informationen

aus Voll-Gummi



NEU

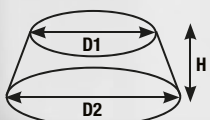

Teile	D1 mm	D2 mm	H mm		
160.0485	1	78	105	60	15, ⁰⁰ CHF

i  **1**
 Weitere Informationen

aus Gummi und Stahlplatte

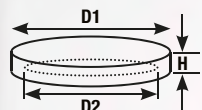

	D1 mm	D2 mm	H mm	Ravaglioli	Grazia	OMCN	Intertech	MAHA	Werther	Nussbaum	AMI	Twin Bush	Sirio	Space	Launch	RP Tools	J.A. Becker	ATH	HOFMANN	Hermann		
A	160.0463	120	113	22				✓														14,00 CHF
B	160.0465	123	108	25	✓				✓													14,00 CHF
C	160.0475	120	110	19													✓	✓	✓	✓		14,00 CHF

i  **1**
 Weitere Informationen

aus Gummi

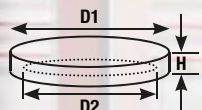

	D1 mm	D2 mm	H mm	Ravaglioli	Grazia	OMCN	Intertech	MAHA	Werther	Nussbaum	AMI	Twin Bush	Sirio	Space	Launch	RP Tools	J.A. Becker	ATH	HOFMANN	Hermann		
A	160.0466	125	120	24						✓	✓											18,00 CHF
B	160.0467	140	130	25								✓										9,00 CHF
C	160.0468	100	85	14	✓								✓	✓								8,00 CHF
D	160.0464	120	113	23				✓														8,00 CHF
E	160.0469	120	108	32								✓			✓	✓						12,00 CHF
F	160.0470	130	125	14	✓								✓	✓		✓						8,00 CHF
G	160.0471	140	125	30								✓										12,00 CHF
H	160.0472	150	130	23	✓																	11,00 CHF
I	160.0473	120	105	30								✓										11,00 CHF
J	160.0474	120	110	19													✓	✓	✓	✓		8,00 CHF
K	160.0490	100	80	21	✓													✓	✓	✓	✓	6,00 CHF
L	160.0491	120	108	26	✓	✓																8,00 CHF
M	160.0492	120	110	26	✓	✓																8,00 CHF
N	160.0493	145	108	24	✓		✓															12,00 CHF
O	160.0494	145	135	26	✓																	11,00 CHF
P	160.0495	160	135	28			✓															11,00 CHF
Q	160.0496	140	103	25						✓												12,00 CHF
R	160.0497	150	127	25	✓																	9,00 CHF
S	160.0498	140	132	28																		14,00 CHF

i **1**
Weitere Informationen



12,00

**Kunststoff-Magnet-Schale,
Ø 150 mm**

800.0156



i **1**
Weitere Informationen



330 mm

15,00

150.2032 Metall-Reifen-Ventilhebel, 330 mm



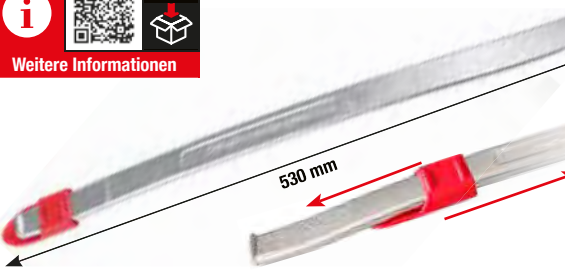

i **1**
Weitere Informationen



530 mm

42,00

911.8135 Runflat Reifen- und Montagehebel



i **1**
Weitere Informationen



75,00

800.0190 Metall-Magnethalter, 390 mm



i **1**
Weitere Informationen



600 mm

0 - 12 bar

30,00

515.1950 Druckluft-Reifenfüllmesser



i **1**
Weitere Informationen

GEEICHT



400 mm

0 - 10 bar

93,00

515.1960 Geeichter Druckluft-Reifenfüllmesser



i **5**
Weitere Informationen



86,00

150.1070 Reifenvulkanisier-Satz für KFZ, inklusive 100 mm Fäden

70 g

9 mm

60 x 100 mm

OPTIONAL ZUM NACHKAUF

60 Stück

27,00

150.1072









i **1**
Weitere Informationen

135,00

Aluminium-Radnabenschleifer-Satz Ø 150 mm, Innen-Ø 90 mm

100.5080

OPTIONAL ZUM NACHKAUF

53,00

100.5077

90 mm

150 mm

VORHER:

NACHHER:

i **4**
Weitere Informationen

8 mm

10 mm

8 mm

8 mm

NEU

OZ Spezial-Alu-Felgen-Stecknuss-Satz für mehrteilige OZ-Felgen

23,00

515.0795

i **3**
Weitere Informationen

60,00

1/2" Spiral-Profil-Kraft-Stecknuss-Satz, 3-tlg, 17-21 mm

913.1270 17 - 19 - 21 mm

i **2**
Weitere Informationen

19,5 mm

18,5 mm

21,5 mm

20,5 mm

+

Spezial-Alu-Felgen-Kraft-Stecknuss-Satz für Ford, 18,5 / 19,5 / 20,5 / 21,5 mm

42,00

515.0895 18,5 - 19,5 - 20,5 - 21,5 mm

i **1**
Weitere Informationen

FÜR MERCEDES

max. 75 Nm

27,00

1/2" Kraft-Torsions-Verlängerung, 75 Nm

515.1491



Weitere Informationen



Radsicherungs-Demontageset

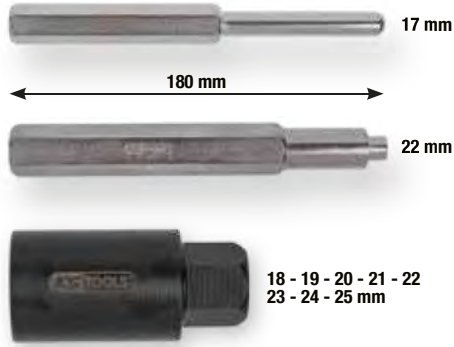

90,00

913.1480 18 - 19 - 20 - 21 - 22 - 23 - 24 - 25 mm



Weitere Informationen

Felgenschloss-Demontage-Satz



210,00



UNIVERSAL GENIAL - DIE PASSEN SICH AN JEDES PROFIL AN!

913.1430

ROBUSTE 1/2" ALU-FELGEN KRAFT-STECKNUSS-SÄTZE

1

Weitere Informationen

21 mm 19 mm 17 mm

27,00

515.1070 1/2" 17 - 19 - 21 mm

2

Weitere Informationen

15 mm 17 mm 19 mm 21 mm 22 mm

38,00

515.0870 1/2" 15 - 17 - 19 - 21 - 22 mm

3

Weitere Informationen

17 mm 15 mm 19 mm 22 mm 23 mm 21 mm 17 mm 21 mm 24 mm 21 mm

105,00

515.0890 1/2" 15 - 17 - 19 - 21 - 22 - 23 - 24 mm 7/8" 17 mm MS21

4

Weitere Informationen

15 mm 17 mm 19 mm 21 mm 22 mm 23 mm 24 mm 17 mm 21 mm

210,00

DER KOMPLETTE ALLESKÖNNER

515.0885 1/2" 15 - 17 - 19 - 21 - 22 - 23 - 24 mm 7/8" 17 mm MS21 17 - 19 - 21 mm 18,5 / 19,5 - 20,5 / 21,5 - 17,5 / 22,5 mm

	515.1072 15 mm	515.1073 17 mm	515.1075 19 mm	515.1076 21 mm	515.1077 22 mm	515.1078 23 mm	515.1079 24 mm	515.1089 Tesla 7/8"	515.2055 Mercedes 17 mm	515.2060 Hyundai KIA MS21	913.1271 Spiralstecknuss 17 mm	913.1272 Spiralstecknuss 19 mm	913.1273 Spiralstecknuss 21 mm	515.0896 Ford 18,5 / 19,5 mm	515.0897 Ford 20,5 / 21,5 mm	515.0899 Ford 17,5 / 22,5 mm	515.1134 Kraft-Verlängerung, 75mm
1	X	✓	✓	✓	X	X	X	X	X	X	X	X	X	X	X	X	X
2	✓	✓	✓	✓	✓	X	X	X	X	X	X	X	X	X	X	X	X
3	✓	✓	✓	✓	✓	✓	✓	✓	✓	✓	X	X	X	X	X	X	X
4	✓	✓	✓	✓	✓	✓	✓	✓	✓	✓	✓	✓	✓	✓	✓	✓	✓

i 1
Weitere Informationen

aufladbar mit USB-C-Kabel (inklusive)

26,00

350 Lumen

UV LED

POWER-AAA Li-Ion 800mAh

mit Laserpointer

LED COB Stripe Inspektionslampe
350 Lumen mit UV-Spot LED und Laserpointer

150.4400

i 1
Weitere Informationen

140 mm

85 Lumen

23,00

25 m

perfectLight
Taschenlampe 85 Lumen

150.4370

+ **2 x AA** ✓

i 1
Weitere Informationen

MAX. 350 Lumen

MAX. 100 Lumen

270°

DAS MUST HAVE!
FÜR WERKSTATT ODER OUTDOOR

23,00

150.4520

Modi COB 100% COB 40% COB rot XPE 100% XPE 40%

Modi	COB 100%	COB 40%	COB RED	XPE 100%	XPE 40%
LED	270° 3 Watt COB LED			1 Watt High Power XPE LED	
40%	350 LM	150 LM	-	100 LM	40 LM
	3 h	6 h	8 h	4 h	8 h

27,00

Weitere Informationen

360°

250 Lumen

500 Lumen

USB

ON OFF

1200 mAh Lithium-Ionen Akku (inklusive)

180°

oder

3x AAA Batterien (nicht im Lieferumfang enthalten)

inklusive USB Power Bank Funktion

20 %	●
40 %	●●
60 %	●●●
80 %	●●●●
100 %	●●●●●

150.4510

max. 3 h

3 h

+

IP65

30,00

Weitere Informationen

130 Lumen

300 Lumen

USB-A OUT

USB-C IN

ON OFF

integrierter Lithium-Ionen Akku 1.200 mAh

20 %	●
40 %	●●
60 %	●●●
80 %	●●●●
100 %	●●●●●

150.4505

max. 3 h

3 h

+

IP65

25,00

Weitere Informationen

60 Lumen

150 Lumen

Micro USB

ON OFF

360°

180°

20 %	●
40 %	●●
60 %	●●●
80 %	●●●●
100 %	●●●●●

150.4495

max. 3,5 h

2,5 h

IP20

57,00

Weitere Informationen

250 Lumen

550 Lumen

USB-A OUT

USB-C IN

ON OFF

integrierter Lithium-Ionen Akku 1.200 mAh

20 %	●
40 %	●●
60 %	●●●
80 %	●●●●
100 %	●●●●●

150.4490

max. 3,5 h

3 h

+

IP65

i  **11**
 Weitere Informationen



20-200 Nm

mit Kalibrier-
 Konformitätserklärung
DIN EN ISO 6789
 Zertifikat
 Kennzahl: 4723

KALIBRIER-KONFORMITÄTSERKLÄRUNG
 (Detailed calibration certificate table)

125 mm

10 mm 13 mm 17 mm 19 mm 21 mm 24 mm

17 mm 19 mm 21 mm

1/2" 500 mm

180,00

516.2400 1/2" 10 - 13 - 17 - 19 - 21 - 24 mm

i  **8**
 Weitere Informationen

**FÜR REIFENWECHSEL
 IN REKORDZEIT**

THE DEVIL

1600 Nm

21 mm 19 mm 17 mm

1/2"

2 x Ø 150 mm

0 - 12 bar

10 m

NEU

180,00

Ihr Partner:

 **4 042146 956694**
 LL23-06D_CHF

KS Tools Werkzeuge - Maschinen GmbH
 Seligenstädter Grund 10 - 12
 D-63150 Heusenstamm
 DEUTSCHLAND

Mail: aftersales@kstools.com
 Web: www.kstools.com

515.2100

Mit Erscheinen dieses Prospektes verlieren alle vorangegangenen Preise hiermit ihre Gültigkeit. Verkauf nur an den Fachhandel. Druckfehler, Irrtümer und technische Änderungen vorbehalten. Alle Preise in CHF zzgl. MwSt. gelten bis 30.09.2024