

TOP DEAL

KSTOOLS

WWW.KSTOOLS.COM

No Limits!

NOTRE COMPÉTENCE CLÉ :

LA QUALITÉ À UN PRIX DÉFIANT TOUTE CONCURRENCE !

EVOLUTION
SERIES



Liste complète
des pièces

917.0255

1/4" + 3/8" + 1/2" + 5/16"

255 PIÈCES
POUR SEULEMENT

180,00

i  397
Plus d'informations

P₁₀

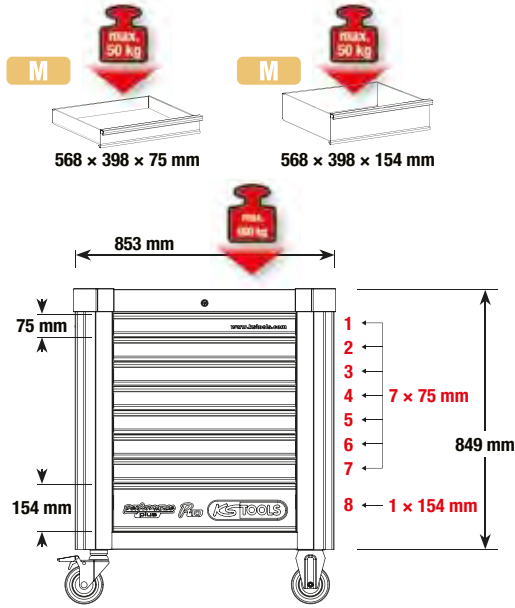

CHOISISSEZ VOTRE PACK DE PUISSANCE

810.7397

Options available for the P10 pack:

- Crochet pour rouleau de papier inclus
- Porte-canette inclus
- Roulement à billes stable
- Roues antistatiques avec frein

i  397
Plus d'informations

P₁₅

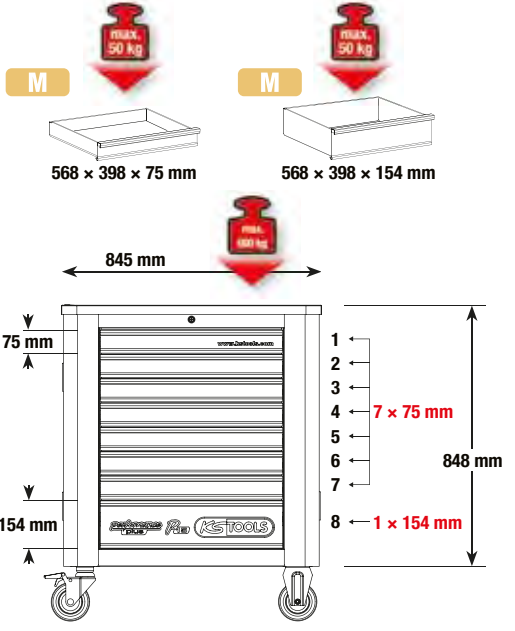

815.7397

LE PACK IDÉAL DE 397 PIÈCES

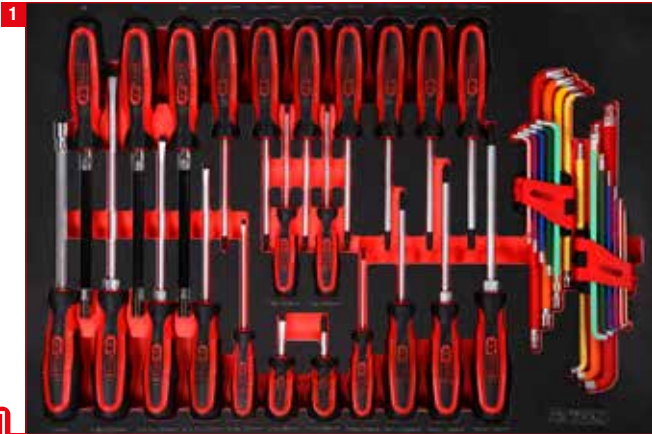

41 Module de tournevis



41 Jeu de clés de serrage

4049,00

810.7397 Chariot d'atelier P10 avec 397 outils



111 1/4" + 3/8" + 1/2" Module de douilles

4199,00

815.7397 Chariot d'atelier P15 avec 397 outils



111 Jeu de douilles à embout 1/2"



28 Jeu de pinces et de limes



43 Jeu d'entretien pour huile et pneus



22 Jeu de marteaux et de burins

BIENVENUE DANS LA



**AVEC 564
OUTILS**

5699,⁰⁰



Protection des angles intégrée



Porte-canette inclus



Roulement à billes stable



Roues antistatiques avec frein



Verrou inclus

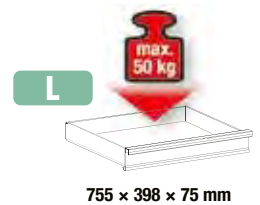
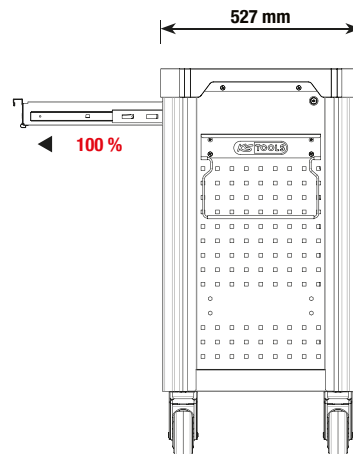
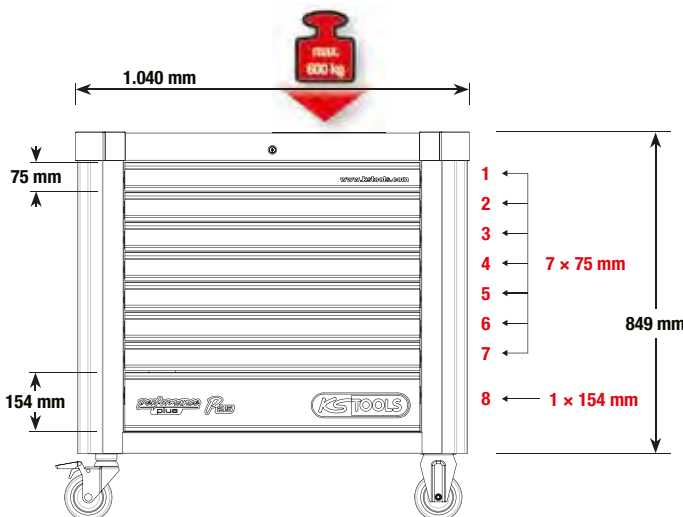

825.8564

CATÉGORIE ROYALE!

Performance
plus

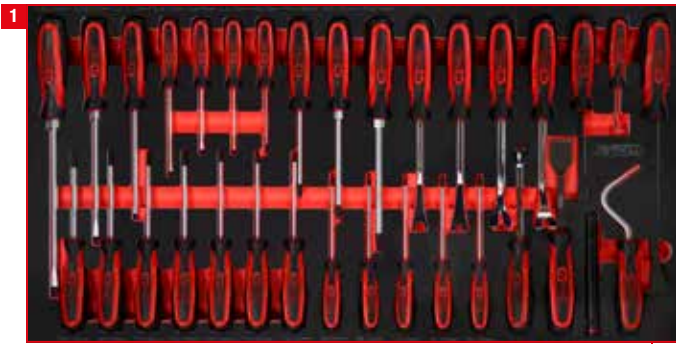

Module de tournevis

33



1/4" + 3/8" Module de douilles

213



1/2" Module de douilles

86



Jeu de clés de serrage

57



Jeu de clés de serrage

54

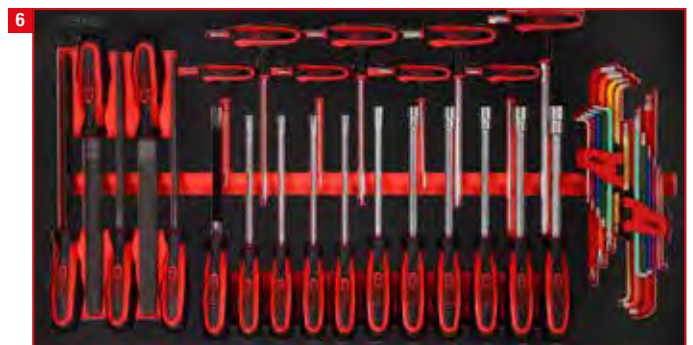

Jeu de tournevis et de limes

42

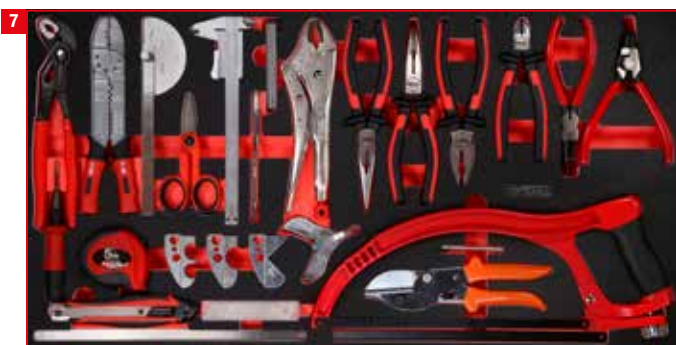

Jeu d'outils de mesure et de pinces

39



Jeu de marteaux, de burins et de douilles à chocs

40

QUEL CHARIOT IL VOUS FAUT ?



Plan de travail avec insert en mousse de 10 mm



Fermeture grâce à la serrure à barillet intégrée



Avec rappel de fermeture et fonction SOFT CLOSE



Perforation à quatre pans pour accessoires



2 roues avec roulements Ø 125mm et freins

ECO Line

675,00

SANS OUTILS



i **1** 897.0007
Plus d'informations

Données techniques :	Eco Line 897.0007	Racing Line 826.0007
Charge maxi :	300,0 kg	350,0 kg
Poids maxi par tiroir :	25,0 kg	30,0 kg
rappel de fermeture et fonction SOFT CLOSE :	✓	✗
Diamètre de roue :	125,0 mm	125,0 mm
Blocage des roues :	✓	✓
Avec verrouillage central :	✓	✓
Verrouillage :	✗	✓
Hauteur :	1014,0 mm	976,0 mm
Largeur :	748 mm	788 mm
Profondeur P :	459,0 mm	496,0 mm
Dimensions intérieures :	565 x 395 mm	565 x 395 mm
Rebords des angles en polyuréthane :	✗	✓
Perforation à quatre pans pour accessoires :	✓	✓
Nombre de tiroirs :	7	7
Épaisseur de feuille :	0,8 mm	0,9 mm
Poignées de tiroir :	✓	✓
Ouverture de tiroir :	100 %	90 %
Plateau de travail avec petits compartiments :	✗	✓
Surface de travail avec inserts en mousse :	✓	✗
Glossière à roulements à billes :	✓	✓
Poignée latérale en acier :	✓	✓

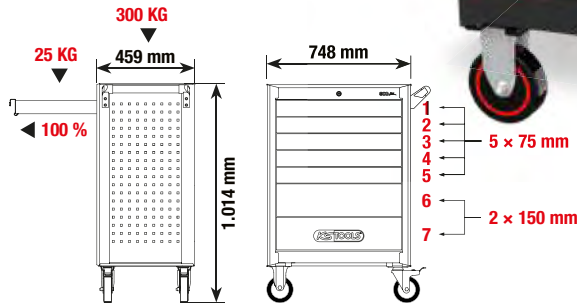

L'EMBARRAS DU CHOIX ? UN CHOIX DE QUALITÉ !

RACING Line



Plan de travail en ABS avec espace de rangement



Fermeture grâce à la serrure à barillet intégrée



Système de verrouillage individuel des tiroirs afin d'éviter toute ouverture intempestive



Perforation à quatre pans pour accessoires



2 roues avec roulements Ø 125mm et freins

750,00

SANS OUTILS

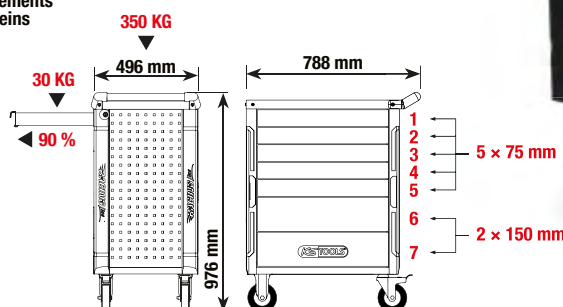

i **1** 826.0007
Plus d'informations

ECO *line*

Avec 7 tiroirs et 215 outils
d'excellente qualité

1020,00

897.7215

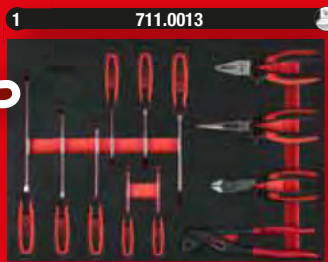

PACK DE DÉPART - 215 PCS



Plus d'informations

RACING *line*

Avec 7 tiroirs et 215 outils
d'excellente qualité

1050,00

826.7215



ECO *line*

Avec 7 tiroirs et 515 outils
d'excellente qualité

1320,00

897.7515



PACK UNIVERSEL - 515 PCS

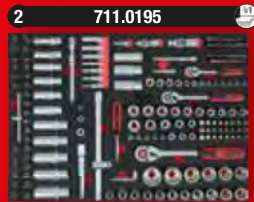
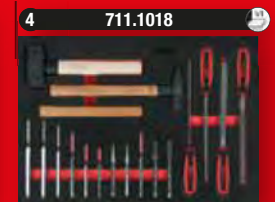
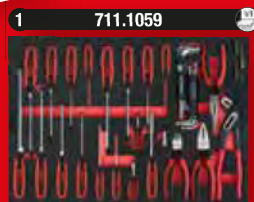

Plus d'informations

RACING *line*

Avec 7 tiroirs et 515 outils
d'excellente qualité

1350,00

826.7515



ECO *line*

Avec 7 tiroirs et 598 outils
d'excellente qualité

1949,00

897.7598



PACK DE PUISSANCE - 598 PCS

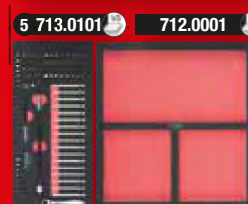

Plus d'informations

RACING *line*

Avec 7 tiroirs et 598 outils
d'excellente qualité

2024,00

826.7598



- DIN 3110 / ISO 1085 / ISO 10102 / ISO 3318
- Fourche inclinée à 15°
- Têtes polies
- Finition satinée
- Chrome Vanadium

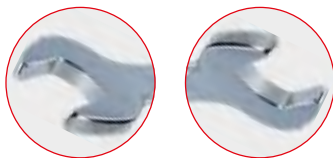

à partir de **30,00**

A	517.0148			6x7 · 8x9 · 10x11 · 12x13 14x15 · 16x17 · 18x19 20x22 mm	30,00 CHF
B	517.0123			6x7 · 8x9 · 10x11 · 12x13 14x15 · 16x17 · 18x19 20x22 · 21x23 · 24x27 30x32 mm	68,00 CHF
C	517.0125			6x7 · 8x9 · 10x11 · 12x13 14x15 · 16x17 · 18x19 20x22 · 21x23 · 24x27 25x28 · 30x32 mm	75,00 CHF



- Système FlankTraction
- Fourche inclinée à 15°
- Œil incliné 15°
- Tête polie
- Finition satinée



à partir de **35,00**

A	517.0048			8 · 9 · 10 · 11 · 13 · 14 17 · 19 mm	35,00 CHF
B	517.0052			8 · 9 · 10 · 11 · 12 · 13 · 14 15 · 16 · 17 · 18 · 19 mm	65,00 CHF
C	517.0043			6 · 7 · 8 · 9 · 10 · 11 · 12 13 · 14 · 15 · 16 · 17 · 18 19 · 20 · 21 · 22 · 24 · 27 30 · 32 mm	165,00 CHF



- 12 pans
- Selon DIN 838 / ISO 1085 / ISO 10104 / ISO 3318
- Œil coudé à 75°
- Parois fine
- Tête polie



à partir de **38,00**

A	517.0248			6x7 · 8x9 · 10x11 · 12x13 14x15 · 16x17 · 18x19 20x22 mm	38,00 CHF
B	517.0222			6x7 · 8x9 · 10x11 · 12x13 14x15 · 16x17 · 18x19 20x22 · 21x23 · 24x27 30x32 mm	75,00 CHF



i **1**
Plus d'informations

23,00

315 mm

22 mm

19 mm

522.1922

i **1**
Plus d'informations

LA CLÉ À CLIQUET RÉVERSIBLE 4 EN 1

10 mm

13 mm

17 mm

19 mm

30,00

72° 5°

503.4565 10 x 13 x 17 x 19 mm

i **1**
Plus d'informations

MULTITÂCHES

Clé multi-fonctions

260 mm

8-17 mm

14-32 mm

114.0055

8 · 9 · 10 · 11 · 12 · 13 · 14 · 15 · 16 · 17 · 18 · 19 · 20 · 21 · 22 · 23 · 24 · 25 · 26 · 27 · 28 · 29 · 30 · 31 · 32 mm

51,00

i **12**
Plus d'informations

72° 5°

180,00

503.4665 8 · 9 · 10 · 11 · 12 · 13 · 14 · 15 · 16 · 17 · 18 · 19 mm

i **30**
Plus d'informations

LE MULTIFONCTION

5/16" x 13 mm

1/2"

10 mm x 13 mm

3/8"

1/4" x 10 mm

1/4"

12 x

12 x

254,00

503.4960 8 · 9 · 10 · 11 · 12 · 13 · 14 · 15 · 16 · 17 · 18 · 19 mm

i Plus d'informations **2**

72 5°

1/2" 305 - 445 mm

1/4" 173 - 223 mm

RÉGLABLE :
1/4" SUR 4 PALIERS
1/2" SUR 6 PALIERS

NOUVEAU

53,00

914.1412

i Plus d'informations **1**

NOUVEAU

600 MM!

460 - 600 mm

72 5°

1/2"

Position: 1 2 3 4 5 6

38,00

RÉGLAGE SUR 6 PALIERS

914.1205

i Plus d'informations **1**

75,00

760 mm

1/2"

**FLEXIBILITÉ MAXIMALE
ET CONTRÔLE OPTIMAL**

918.1293

72 5°

**PUISSANCE ET RÉSISTANCE -
FONCTION INNOVANTE**

A B C

1/4" 3/8" 1/2"

à partir de **38,00**

			Nm	↔	
A	920.1490		102	140 mm	38,00 CHF
B	920.3890		325	190 mm	45,00 CHF
C	920.1290		710	245 mm	55,00 CHF

102 Nm

710 Nm

72 5°

83,00

920.0002 **i** Plus d'informations **2**

LES MEILLEURES QUE NOUS AYONS JAMAIS FABRIQUÉES !

Nous connaissons nos capacités. Et parce que nous savons exactement à quel point notre nouvelle gamme de clés à cliquet Monster est de qualité, il est tout naturel pour nous de vous offrir une garantie sur chaque modèle. Pas 2 ou 3 ans.

Non, 10 ans ! Pour que la garantie soit aussi haut de gamme que nos clés à cliquet Monster !



1 80°/4.5° **45,00** **1/4"** **935.1490** **106 g** **125 mm** **>110 Nm**

Plus d'informations

2 80°/4.5° **45,00** **1/4"** **935.1495** **106 g** **125 mm** **>100 Nm**

Plus d'informations

3 96°/3.75° **60,00** **3/8"** **935.3890** **227 g** **199 mm** **>365 Nm**

Plus d'informations

GARANTIE : 6 MONSTER À VIE !

4 100°/3.6° **75,00** **1/2"** **935.1290** **567 g** **275 mm** **>950 Nm**

Plus d'informations

5 100°/3.6° **105,00** **1/2"** **935.1295** **757 g** **425 mm** **>950 Nm**

Plus d'informations

6 100°/3.6° **150,00** **1/2"** **935.1285** **1.280 g** **406 - 635 mm** **>950 Nm**

Plus d'informations

TÉLESCOPIQUE

NOUVEAU

-15%

>950 Nm **1/2"** **935.0002** **>110 Nm** **1/4"** **105,00**

Plus d'informations



9

Jeu de douilles à embout pour vis à six pans creux, courtes

3/8"

4 mm 5 mm 6 mm 7 mm 8 mm 9 mm 10 mm 12 mm 14 mm



NOUVEAU

53,00

917.4000 4 - 5 - 6 - 7 - 8 - 9 - 10 - 12 - 14 mm

UN EMBOUT, SVP ! MAIS UN COURT !



10

Jeu de douilles à embout pour vis Torx, courtes

3/8"

T10 T15 T20 T25 T27 T30 T40 T45 T50 T55

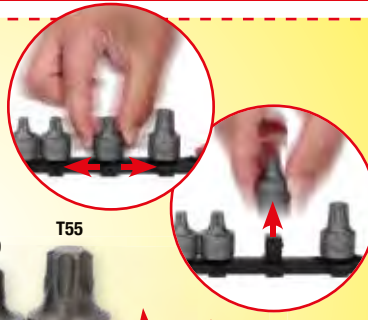

NOUVEAU

60,00

917.4015 T10 - T15 - T20 - T25 - T27 - T30 - T40 - T45 - T50 - T55

NOMBRE TOTAL D'EMBOUS TORX : TOUT DANS UN SEUL COFFRET



77

Plus d'informations

5 x		1/4": E4 - E5 - E6 - E7 - E8
4 x		3/8": E10 - E12 - E14 - E16
4 x		1/2": E18 - E20 - E22 - E24
5 x		1/4": EPL4 - EPL5 - EPL6 - EPL7 - EPL8
4 x		3/8": EPL10 - EPL12 - EPL14 - EPL16
4 x		1/2": EPL18 - EPL20 - EPL22 - EPL24
8 x		1/4": T6 - T8 - T10 - T15 - T20 - T25 - T27 - T30
5 x		3/8": T40 - T45 - T47 - T50 - T55
2 x		1/2": T60 - T70
7 x		1/4": TB8 - TB10 - TB15 - TB20 - TB25 - TB27 - TB30
4 x		3/8": TB40 - TB45 - T50 - T55
1 x		1/2": TB60
7 x		1/4": IP8 - IP10 - IP15 - IP20 - IP25 - IP27 - IP30
3 x		3/8": IP40 - IP45 - IP50
2 x		1/2": IP55 - IP60
7 x		1/4": IPR8 - IPR10 - IPR15 - IPR20 - IPR25 - IPR27 - IPR30
3 x		3/8": IPR40 - IPR45 - IPR50
2 x		1/2": IPR55 - IPR60

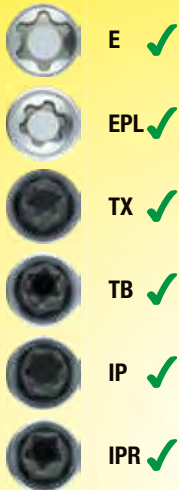

150,00

NOUVEAU



EVOLUTION SERIES

1/4" + 3/8" + 1/2"



911.0077

i **30**
Plus d'informations

EVOLUTION SERIES

NOUVEAU

120,00

1/2"

911.4510

55 mm		5 - 6 - 7 - 8 - 10 - 12 - 14 - 17 - 19 mm
100 mm		5 - 6 - 7 - 8 - 10 - 11 - 12 - 13 mm
140 mm		5 - 6 - 7 - 8 - 10 - 12 - 14 mm
200 mm		5 - 6 - 7 - 8 - 10 - 12 mm

STAINLESS STEEL

i **32**
Plus d'informations

EVOLUTION SERIES

NOUVEAU

120,00

1/2"

911.4520

55 mm		M5 - M6 - M7 - M8 - M9 - M10 - M12 - M13 - M14
100 mm		M5 - M6 - M7 - M8 - M9 - M10 - M12 - M13 - M14
140 mm		M7 - M8 - M9 - M10 - M12 - M13 - M14
200 mm		M7 - M8 - M9 - M10 - M12 - M13 - M14

STAINLESS STEEL

i **26**
Plus d'informations

EVOLUTION SERIES

NOUVEAU

120,00

1/2"

911.4540

55 mm		M5 - M6 - M8 - M9 - M10 - M12 - M14 - M16
100 mm		M5 - M6 - M8 - M9 - M10 - M12 - M14
140 mm		M5 - M6 - M8 - M9 - M10 - M12 - M14
200 mm		M8 - M10 - M12 - M14

STAINLESS STEEL

i **32**
Plus d'informations

EVOLUTION SERIES

NOUVEAU

120,00

1/2"

911.4550

55 mm		T20 - T25 - T27 - T30 - T40 - T45 - T50 - T55 - T60 - T70
100 mm		T20 - T25 - T27 - T30 - T40 - T45 - T50 - T55 - T60 - T70
140 mm		T40 - T45 - T50 - T55 - T60 - T70
200 mm		T40 - T45 - T50 - T55 - T60 - T70

STAINLESS STEEL

A Finition satinée **B** Finition chromée

à partir de **42,00**

Acier nickelé

A	917.0648		48	42,00 CHF	1/4"	
B	918.0648		48	45,00 CHF	1/4"	

4 - 4,5 - 5 - 5,5 - 6 - 7 - 8 - 9
10 - 11 - 12 - 13 - 14 mm

i **20**
Plus d'informations

8°

45

R

L

Finition satinée

90,00

1/2"

10 - 11 - 12 - 13 - 14 - 15 - 16
17 - 18 - 19 - 20 - 21 - 22 - 24
27 - 30 - 32 mm

911.0620

A Finition satinée **B** Finition chromée

à partir de **120,00**

Acier nickelé

A	911.0694		94	120,00 CHF	1/4" + 1/2"	
B	918.0694		94	135,00 CHF	1/4" + 1/2"	

4 - 4,5 - 5 - 5,5 - 6 - 7 - 8 - 9
10 - 11 - 12 - 13 - 14 - 15 - 16
17 - 18 - 19 - 20 - 21 - 22 - 23
24 - 27 - 30 - 32 mm

i **108**
Plus d'informations

8°

45

R

L

Finition satinée

135,00

1/4" + 1/2"

Acier nickelé

4 - 4,5 - 5 - 5,5 - 6 - 7 - 8 - 9
10 - 11 - 12 - 13 - 14 - 15 - 16
17 - 18 - 19 - 20 - 21 - 22 - 24
27 - 30 - 32 mm

911.0708



Plus d'informations

1/4"	<ul style="list-style-type: none"> 4 - 4,5 - 5 - 5,5 - 6 - 7 - 8 - 9 - 10 - 11 - 12 - 13 - 14 mm 4 - 5 - 6 - 7 - 8 - 9 - 10 mm E4 - E5 - E6 - E7 - E8
3/8"	<ul style="list-style-type: none"> 10 - 11 - 12 - 13 - 14 - 15 - 16 - 17 - 18 - 19 mm 10 - 11 - 12 - 13 - 14 - 15 mm E10 - E11 - E12 - E14 - E16 - E1
1/2"	<ul style="list-style-type: none"> 10 - 11 - 12 - 13 - 14 - 15 - 16 - 17 - 18 - 19 - 20 - 21 - 22 - 24 - 27 - 30 - 32 mm 16 - 17 - 18 - 19 - 22 mm E20 - E24
1/4" 5/16"	<ul style="list-style-type: none"> 10 - 11 - 12 - 13 - 14 - 15 - 16 - 17 - 18 - 19 - 20 - 21 - 22 - 24 - 27 - 30 - 32 mm
1/4" - 3/8" 1/2"	<ul style="list-style-type: none"> 50 - 100 - 125 - 150 - 250 mm 1,3 - 1,5 - 2 - 2,5 - 3 - 4 - 5 mm
1/4" - 3/8" 1/2"	<ul style="list-style-type: none"> 1,3 - 1,5 - 2 - 2,5 - 3 - 4 - 5 mm
1/4" - 3/8" 1/2"	<ul style="list-style-type: none"> 1/4" - 5/16"
1/4"	

1/4" + 3/8" + 1/2"

Acier nickelé

Finition satinée

917.0779



143,00

1/4"	<ul style="list-style-type: none"> 4 - 4,5 - 5 - 5,5 - 6 - 7 - 8 - 9 - 10 - 11 - 12 - 13 - 14 mm 6 - 7 - 8 - 9 - 10 - 11 - 12 - 13 - 14 - 15 mm
3/8"	<ul style="list-style-type: none"> 10 - 11 - 12 - 13 - 14 - 15 - 16 - 17 - 18 - 19 mm 10 - 11 - 12 - 13 - 14 - 15 mm
1/2"	<ul style="list-style-type: none"> 10 - 11 - 12 - 13 - 14 - 15 - 17 - 18 - 19 - 20 - 21 - 22 - 24 - 27 - 30 - 32 mm 17 - 19 - 22 mm
1/4" 5/16"	<ul style="list-style-type: none"> 10 - 11 - 12 - 13 - 14 - 15 - 16 - 17 - 18 - 19 - 20 - 21 - 22 - 24 - 27 - 30 - 32 mm
12 x	<ul style="list-style-type: none"> 8 - 9 - 10 - 11 - 12 - 13 - 14 - 15 - 16 - 17 - 18 - 19 mm 1,3 - 1,5 - 2 - 2,5 - 3 - 4 - 5 mm
1/4" - 3/8" 1/2"	
1/4"	



A Finition satinée

B Finition chromée

A 917.0216



216

263,00 CHF

Acier nickelé

B 918.0216



216

285,00 CHF

1/4" + 3/8" + 1/2"

à partir de 263,00



A	911.0721			21		19 · 21 · 22 · 23 · 24 · 26 · 27 · 29 · 30 32 · 35 · 36 · 38 · 41 · 46 · 50 mm	330, ⁰⁰ CHF
B	911.0722			21		19 · 21 · 22 · 23 · 24 · 26 · 27 · 29 · 30 32 · 35 · 36 · 38 · 41 · 46 · 50 mm	373, ⁰⁰ CHF
C	911.0751			21		3/4" · 13/16" · 7/8" · 15/16" · 1" 1.1/16" · 1.1/8" · 1.3/16" · 1.1/4" 1.5/16 · 1.3/8" · 1.7/16" · 1.1/2" 1.5/8" · 1.3/4" · 2"	373, ⁰⁰ CHF

à partir de
330,⁰⁰

			82
Plus d'informations			
1/4"			4 - 4,5 - 5 - 5,5 - 6 - 7 - 8 - 9 - 10 - 11 12 - 13 - 14 mm
1/2"			14 - 15 - 16 - 17 - 18 - 19 - 20 - 21 - 22 24 - 27 - 30 - 32 mm
1/4"			16 - 21 mm
1/4"			
5/16"			
1/4"			
1/2"			
1/4"			150 mm
1/4"			50 - 100 - 125 - 250 mm
1/2"			
1/4"			150 mm
12 x			8 - 10 - 11 - 12 - 13 - 14 - 17 - 19 - 22 mm



195,⁰⁰

911.0682 **1/4" + 1/2"**

i  **47**
Plus d'informations



1/2"		10 - 11 - 12 - 13 - 14 - 15 - 16 - 17 18 - 19 - 20 - 21 - 22 - 24 mm
3 x		16 - 18 - 21 mm
14 x		6 - 7 - 8 - 9 - 10 - 11 - 12 - 13 - 14 15 - 16 - 17 - 18 - 19 mm
1 x		250 mm
2 x		125 - 250 mm
1 x		1/2"
5 x		3 - 5,5 - 8 mm + PH1 - PH2
1 x		T8 - T10 - T15 - T20 - T25 - T27 T30 - T40
1 x		2,5 - 3 - 4 - 5 - 6 - 7 - 8 - 10 mm
1 x		3 - 48 V
1 x		240 mm
1 x		180 mm
1 x		300 g















Finition satinée

225,00

1/2"

940.0047



1/4"		4 - 4,5 - 5 - 5,5 - 6 - 7 - 8 - 9 - 10 11 - 12 - 13 mm
1/2"		10 - 11 - 12 - 13 - 14 - 15 - 16 - 17 19 - 20 - 21 - 22 - 24 - 27 - 30 - 32 mm
12 x		8 - 9 - 10 - 11 - 12 - 13 - 14 - 15 - 16 17 - 18 - 19 mm
2 x		1/4": 100 mm / 1/2": 125 mm
1 x		1/4" / 1/2"
7 x		3 - 4 - 5,5 - 6,5 mm + PH0 - PH1 - PH2
1 x		T8 - T10 - T15 - T20 - T25 - T27 - T30 T40 - T45 - T50
1 x		1,5 - 2 - 2,5 - 3 - 4 - 5 - 6 - 8 - 10 mm
1 x		
1 x		300 g
1 x		160 mm
1 x		200 mm



B

A

1/4" + 1/2"

A Finition satinée

B Finition chromée

A

917.0797



263,00 CHF

B

918.0797



285,00 CHF

Acier nickelé



à partir de
263,00

Plus d'informations

1/4"		4 - 4,5 - 5 - 5,5 - 6 - 7 - 8 - 9 - 10 - 11 12 - 13 mm
1/2"		14 - 15 - 16 - 17 - 18 - 19 - 20 - 21 - 22 23 - 24 - 25 - 26 - 27 - 28 30 - 32 mm
12 x		6 - 7 - 8 - 9 - 10 - 11 - 12 - 13 - 14 17 - 19 - 22 mm
3 x		1/4": 50 - 100 mm / 1/2": 125 mm
1 x		1/4"
4 x		6,5 - 8 mm PH1 - PH2
1 x		1/4"
1 x		1/4"
1 x		150 - 250 V
1 x		250 mm
1 x		180 mm
1 x		300 g

285,00

Finition satinée

911.0688

1/4"
1/2"

Plus d'informations

LE MULTIFONCTION

1

4 x

2

8 x 8 - 9 - 10 - 11 - 13
14 - 17 - 19 mm

3

4

4 - 4,5 - 5 - 5,5 - 6 - 7
8 - 9 - 10 - 11 - 12
13 - 14 mm

1/4"

1/2"

555,00

911.0727

1/4"
1/2"

490 mm

400 mm



Plus d'informations



6 x

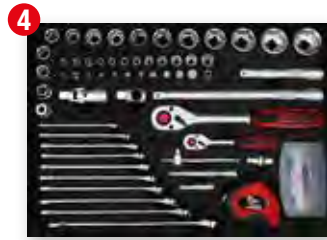

1/4"		4 - 4,5 - 5 - 5,5 - 6 - 7 8 - 9 - 10 - 11 - 12 13 mm
1/2"		10 - 13 - 14 - 15 - 16 17 - 18 - 19 - 21 - 22 24 - 27 - 30 - 32 mm
10 x		8 - 10 - 11 - 12 - 13 14 - 15 - 17 - 19 - 22 mm



585,00

911.0649

1/4" + 1/2"

**VOUS AVEZ BESOIN D'UN ÉQUIPEMENT COMPLET ?
FAITES VOTRE CHOIX !**



Plus d'informations



6 x

3 x



9 x		1,5 - 2 - 2,5 - 3 - 4 - 5 - 6 8 - 10 mm
9 x		TS10 - TS15 - TS20 - TS25 TS27 - TS30 - TS40 - TS45 TS50



1/4"		4 - 4,5 - 5 - 5,5 - 6 - 7 8 - 9 - 10 - 11 - 12 13 mm
1/2"		10 - 11 - 12 - 13 - 14 15 - 16 - 17 - 18 - 19 21 - 22 - 24 - 27 - 30 32 mm
11 x		8 - 9 - 10 - 11 - 12 13 - 14 - 16 - 17 - 19 22 mm



675,00

911.0630

1/4" + 1/2"



POUR LES ÉLECTRICIENS

1

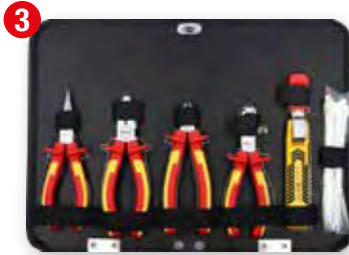

4 x

1/4" 4 - 4,5 - 5 - 5,5 - 6 - 7 - 8
9 - 10 - 11 - 12 - 13 mm

1/2" 10 - 11 - 12 - 13 - 14 - 15
16 - 17 - 18 - 19 - 21 - 22 mm

10 x 8 - 10 - 11 - 12 - 13 - 14
15 - 17 - 19 - 22 mm



585,00

911.0628

1/4" + 1/2"



L'OUTIL POLYVALENT

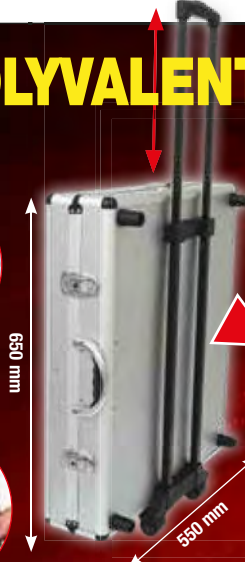

1/4" 4 - 5 - 6 - 7 - 8 - 9 - 11
12 - 13 mm

1/2" 10 - 11 - 12 - 13 - 14 - 15 - 16
17 - 18 - 19 - 21 - 22 - 24 mm

10 x 8 - 9 - 10 - 11 - 12 - 13
14 - 16 - 17 - 18 - 19 mm

780,00

911.0735

1/4" + 1/2"

LES COFFRETS À TRÉSOR !



Plus d'informations



Plus d'informations



1/4"	4 - 5 - 6 - 7 - 8 - 9 - 10 - 11 - 12 13 - 14 mm
1/2"	13 - 15 - 17 - 18 - 19 - 20 - 21 - 22 24 - 27 - 30 - 32 mm



CLÉS MIXTES À CLIQUET

VOUS AVEZ LE CHOIX !

CLÉ MIXTE

8 - 9 - 10 - 11 - 12 - 13 - 14 - 15 - 16 - 17 - 18 - 19 mm

8 - 9 - 10 - 11 - 12 - 13 - 14 - 15 - 16 - 17 - 18 - 19 mm

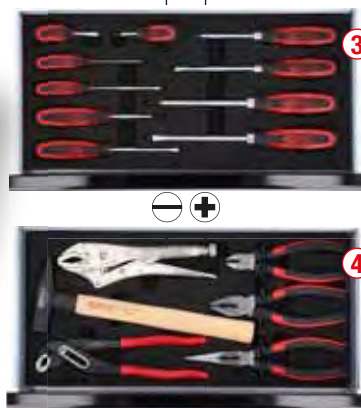

900,00

780,00

1/4" 1/2"

1/4" 1/2"



918.0100

918.0200



Plus d'informations



- 1/2"
- 9 - 10 - 11 - 12 - 13 - 14 - 15 - 16 - 17 - 18
19 - 20 - 21 - 22 - 23 - 24 - 26 - 27 - 30 mm
- 9 - 10 - 11 - 12 - 13 - 14 - 15 - 16 - 17 - 18
19 - 20 - 21 - 22 - 23 - 24 - 26 - 27 - 30 mm

173,00

1/2"

515.0065





1
Plus d'informations



R
L



à partir de
150,00





Graduation avec loupe

Graduation micrométrique



		Nm	Répartition Nm	Lbf-ft		
516.1402		1/4"	1-5	0,10	0,8 - 3,6	150,00 CHF
516.1412		1/4"	5-25	0,10	0,8 - 18	150,00 CHF
516.1422		3/8"	10-50	0,25	4 - 37	150,00 CHF
516.1432		1/2"	20-100	0,50	8 - 75	167,00 CHF
516.1442		1/2"	40-200	1,00	15 - 150	167,00 CHF
516.1472		1/2"	60-320	1,00	45 - 236	188,00 CHF
516.1482		1/2"	80-420	1,00	60 - 310	204,00 CHF
516.1493		3/4"	150-750	10,00	150 - 550	884,00 CHF
516.1495		1"	200-1000	20,00	220 - 730	1011,00 CHF





22
Plus d'informations

3 EN 1



1 2 3



LONG

15,00



1,27 - 1,5 - 2 - 2,5 - 3 - 3,5 - 4 - 4,5 - 5 - 6 - 7 - 8 - 10 mm

T10 - T15 - T20 - T25 - T27 - T30 T40 - T45 - T50

LONG

20,00

A	151.2100			8	2 - 2,5 - 3 - 4 - 5 - 6 8 - 10 mm	15,00 CHF
B	151.2300			8	T10 - T15 - T20 - T25 T30 - T40 - T45 - T50	15,00 CHF

LES 22 PRINCIPALES CLÉS EN UN JEU

32
Plus d'informations



Acier nickelé

1 x	1/4"
1 x	1/4"
3 x	PH1 - PH2 - PH3
6 x	2 x PZ1 - 2 x PZ2 - 2 x PZ3
3 x	5,5 - 6,5 - 8 mm
3 x	4 - 5 - 6 mm
15 x	2 x TB10 - 3 x TB15 - 2 x TB20 3 x TB25 - 3 x TB30 - 2 x TB40

911.2060



25 mm



50 mm

32
Plus d'informations

TORION power

+30%

1 x	1/4"
1 x	1/4"
4 x	3 - 4 - 5 - 6 mm
4 x	PH1 - 2 x PH2 - PH3
4 x	PZ1 - 2 x PZ2 - PZ3
4 x	3 - 4 - 5 - 6 mm
7 x	T10 - T15 - T20 - T25 - T27 - T30 - T40
7 x	TB10 - TB15 - TB20 - TB25 - TB27 - TB30 - TB40

911.3030

14,00 15,00

108
Plus d'informations

TORION power

25 mm

- 6x: 4 - 5 - 6 mm
- 6x: 4 - 5 - 6 mm
- 6x: PH1 - PH2 - PH3
- 6x: PZ1 - PZ2 - PZ3
- 6x: T10 - T15 - T20 - T25 - T30 - T40

918.3108

NOUVEAU

TORION power

+30%

108 EMBOUTS QUI FONT LA DIFFÉRENCE

45,00

32
Plus d'informations



68 mm

100 mm

4 x	3 - 4 - 5 - 6 mm
4 x	PH1 - 2 x PH2 - PH3
4 x	PZ1 - 2 x PZ2 - PZ3
4 x	3 - 4 - 5 - 6 mm
7 x	T10 - T15 - T20 - T25 T27 - T30 - T40
7 x	TB10 - TB15 - TB20 - TB25 TB27 - TB30 - TB40

918.3010

Mini

-22,1%

TORION power

+30%

68,00

31
Plus d'informations



2 x	4 - 5 mm
3 x	PH1 - PH2 - PH3
3 x	PZ1 - PZ2 - PZ3
9 x	1,5 - 2 - 2,5 - 3 - 4 - 5 - 6 7 - 8 mm
11 x	T6 - T7 - T8 - T9 - T10 - T15 T20 - T25 - T27 - T30 - T40

918.3015

Mini

-49%

TORION power

+30%

87,00

i **24**
Plus d'informations

PETIT ET FIN

25 mm
Acier nickelé

30,00

1 x		1/4": 92 mm
1 x		1/4": 50 mm
1 x		1/4"
6 x		6 - 7 - 8 - 10 - 11 - 13 mm
2 x		PH1 - PH2
2 x		PZ1 - PZ2
2 x		4,5 - 5,5 mm
4 x		3 - 4 - 5 - 6 mm
5 x		TB10 - TB15 - TB20 - TB25 - TB30

911.2010 **1/4"**

i **208**
Plus d'informations

60,00

IL PEUT TOUT VISSER !

1/4"		1/4": 205 mm
138 x		25 mm
29 x		50 mm
18 x		75 mm
20 x		4 - 5 - 6 - 7 - 8 - 9 - 10 - 11 - 12 - 13 mm 5/32" - 3/16" - 7/32" - 1/4" - 9/32" 5/16" - 11/32" - 3/8" - 7/16" - 1/2"
1 x		1/4": 50 mm
1 x		1/4"

911.2008 **1/4"**

i **7**
Plus d'informations

UN PETIT BIJOU DE TECHNOLOGIE !

15,00

6 IN ONE

110 mm

NOUVEAU

- 4 - 5 mm
- PH1 - PH2
- PZ1 - PZ2

911.2025 **1/4"**

6 en 1 Tournevis tom pouce à cliquet

i **13**
Plus d'informations

23,00

12 IN ONE

240 mm

- 4 - 5 - 6 mm
- PH1 - PH2 - PH3
- 3 - 4 - 5 mm
- T15 - T20 - T25

911.2035 **1/4"**

Tournevis cliquet 12-en-1 pour embouts

1
Plus d'informations

2 EN 1

1/4" **OU**

85 mm

14,00

514.1126

1
Plus d'informations

1/4" **17,00**

ARTICULÉE

90 mm

20°

514.1136

21
Plus d'informations

4 mm

30 mm 165 mm

Ø 16 mm

1 - 1,3 - 1,5 - 2 - 2,5 - 3 mm

PH00 - PH0 - PH1 - PH2

1,5 - 2 - 2,5 - 3 - 3,5 mm

T3 - T4 - T5 - T6 - T7

60,00

500.7195

27
Plus d'informations

LED

1/4"

eMONSTER

TOUCHÉ UNE FOIS, SÉDUIT POUR TOUJOURS.

53,00

515.3600

4x		3,0 - 4,0 - 5,0 - 6,0 mm
4x		3,0 - 4,0 - 5,0 - 6,0 mm
5x		PH0 - PH1 - PH2 - PH3
4x		PZ0 - PZ1 - PZ2 - PZ3
4x		T10 - T15 - T20 - T25
4x		#0 - #1 - #2 - #3
1x		PH1
1x		50 mm
1x		Max. 6 Nm

max 6 Nm

max 4 Nm

max 2 Nm

3,6 V

1.500 mAh

300 rpm

USB-C

2+ LED



51



Plus d'informations

L'OUTIL POLYVALENT



1 Percer



2 Nettoyage



3 Ponçage



23x



4 Gravure

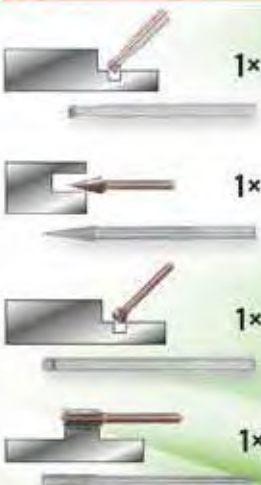

5 Couper



6 Polissage



Jeu d'outil multifonction eMONSTER sans fil avec 50 accessoires



eMONSTER



75,⁰⁰

515.3990



50



Plus d'informations

À RACHETER



Jeu d'accessoires, 50 pcs

15,⁰⁰

515.3992

LA SUPER-HÉROÏNE DES VISSEUSES



eMONSTER

Vitesse élevée
de 210 tr/min,
donc 5 fois plus
rapide que le
processus de
serrage manuel

Affichage pratique de
l'état de charge de la
batterie avec 3 LED

Engrenage
renforcé

Fixation magnétique
des embouts

1/4"

Présélection du couple
réglable sur 10 niveaux

Lampe intégrée

Confort de prise en
main amélioré

Batterie
de 1,3 Ah avec
une autonomie de
plus de 1000
vis

Grâce au port USB-C, la batterie
Li-ION haute performance est
également rapidement
rechargée et prête à l'emploi.



Plus d'informations

25
embouts
inclus



60,00

515.6500

ERGOTORQUE^{plus}

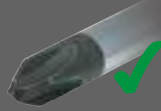

Chromée avec pointe brunie



Avec marquage du profilé sur la poignée

i **5**
Plus d'informations

159.0005

15,00

PH1 PH2 6,5 mm 5,5 mm 4 mm

i **6**
Plus d'informations

159.0030

30,00

T10 T15 T20 T25 T30 T40

i **6**
Plus d'informations

159.0040

30,00

TB10 TB15 TB20 TB25 TB30 TB40

i **39**
Plus d'informations

77,00

6 x		3 - 4 - 5,5 - 6,5 8 - 10 mm	7 x		2 - 2,5 - 3 - 4 - 5 6 - 8 mm
5 x		PH0 - PH1 - PH2 PH3 - PH4	7 x		TB10 - TB15 - TB20 TB25 - TB27 - TB30 TB40
4 x		PZ0 - PZ1 - PZ2 PZ3	7 x		T10 - T15 - T20 T25 - T27 - T30 T40
1 x		6 mm	1 x		1/4"
1 x		PH2	1 x		205 mm

159.0100 **1/4"**

i **13**
Plus d'informations

IL ENCAISSE LES CHOCS !

102,00

Lame traversante

5 x		3,5 - 5,5 - 7 - 8 - 10 mm
5 x		PH0 - PH1 - PH2 - PH3 - PH4
1 x		6 mm
1 x		PH2
1 x		1/4"

151.1150 **1/4"**

i  **15**
Plus d'informations

260 mm



A

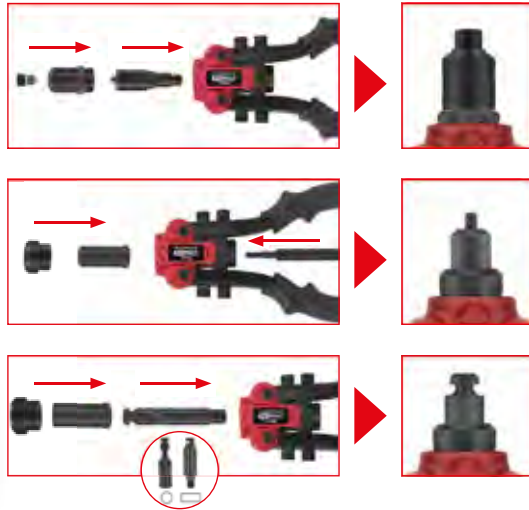

102,00

150.9805



		A	B
		150.9805	150.9630
	dans la valise	✓	✓
	longueur mm	260	510
	grignoteuse	✓	✗
	opération à une ou deux mains		
	M10	✓	✓
	M8	✓	✓
	M6	✓	✓
	M5	✓	✓
	M4	✓	✓
	M3	✓	✓
	Acier 4,8 mm	✓	✓
	Acier 4,0 mm	✓	✓
	Acier 3,2 mm	✓	✓
	Acier 2,4 mm	✓	✓
	Aluminium 6,4 mm	✓	✓
	Aluminium 4,8 mm	✓	✓
	Aluminium 4,0 mm	✓	✓
	Aluminium 3,2 mm	✓	✓
	Aluminium 2,4 mm	✓	✓

i  **17**
Plus d'informations



B

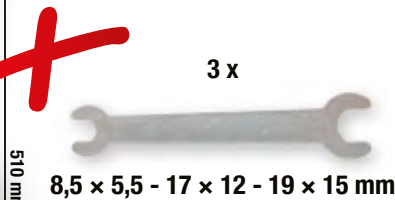

263,00



M4 - M5 - M6 - M8 - M10



6 mm

150.9630





1
Plus d'informations





à partir de **17,00**



35 - 90 mm



	↔	↔	
115.2011	175 mm	7"	17,00 CHF
115.2010	240 mm	10"	20,00 CHF
115.2012	300 mm	12"	24,00 CHF
115.2016	415 mm	16"	48,00 CHF

4
Plus d'informations

CrV	DIN 5254 A	DIN 5254 B	DIN 5256 C	DIN 5256 D
-----	------------	------------	------------	------------

QUALITÉ PREMIUM !

4
Plus d'informations



A 19 - 60 mm



B 40 - 100 mm

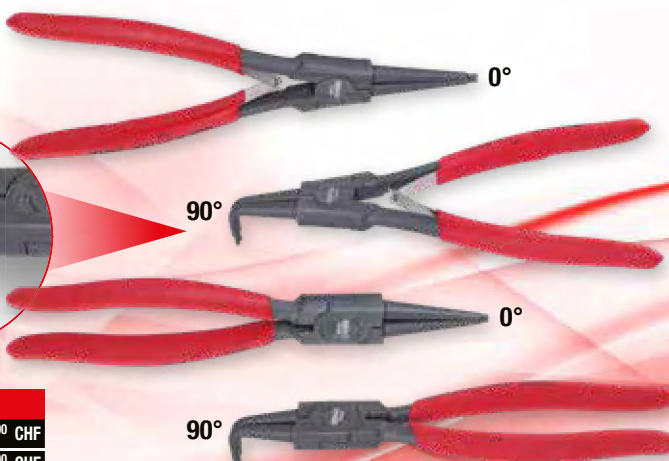

à partir de **167,00**

	↺ ↻	↔	
A	119.2055	19 - 60 mm	160 mm
B	119.2060	40 - 100 mm	230 mm





20
Plus d'informations

PRIORITÉ À LA SÉCURITÉ



60 - 100 mm



40 - 85 mm



75,00



0° 15° 45° 90°
90° 45° 15° 0°

500.1350

Coffret de pinces à circlips à crémaillère

i **10**
Plus d'informations

38,00

260 mm

300 mm

1 x		120 mm	1 x		160 mm
1 x		120 mm	3 x		PH00 - PH0 - PH1
1 x		120 mm	3 x		2,0 - 2,4 - 3,0 mm

500.7220

i **21**
Plus d'informations

150,00

ESD

430 mm

370 mm

2 x		125 - 130 mm	3 x		PH00 - PH0 - PH1
1 x		100 mm	4 x		1,4 - 2,0 - 2,4 - 3,0 mm
1 x		100 mm	7 x		T6 - T7 - T8 - T9 - T10 - T15 - T20
1 x		125 mm			
1 x		150 mm			
1 x		145 mm			

500.7190

i **1**
Plus d'informations

9,00

500g

Pointe de réglage

Ø 8,0 mm

150 - 675 mm

Avec tête magnétique rigide

550.1001

Crochet magnétique télescopique 2 en 1 avec buses de nettoyage et outil de réglage

i **1**
Plus d'informations

12,00

2,5 kg

Tige de nettoyage fine

Ø 11,0 mm

150 - 590 mm

Tête aimantée flexible

550.1023

Crochet magnétique télescopique 2 en 1 avec buses de nettoyage et outil de réglage

i **1**
Plus d'informations

15,00

260 - 760 mm

50 x 80 mm

max. 60 h

1 x CR 2032

LED

550.1136

Miroir d'inspection flexible avec éclairage

i **5**
Plus d'informations

23,00

NOUVEAU

5 EN 1

Verrouillage rapide inclus

LED

3 x LR44

Ø 52,0 mm

Ø 31,0 mm

90,0 x 50,0 mm

172 - 640 mm

3,6 kg

550.1145

i **4**
Plus d'informations

15,00

45° 135° 0° 90°

550.1045

i **9**
Plus d'informations

30,00

45° 135° 0° 90° 45° 90° 0°

550.1070

i **1**
Plus d'informations

14,00

Piezo

115 mm

960.1110

i **1**
Plus d'informations

30,00

300 mm

550.1060

i **8**
Plus d'informations

30,00

95 mm

Ø 40 mm

49 mm

5 mm

Ø 1,6 mm

Ø 3,5 mm

Ø 4,5 mm

960.1265

i **11**
Plus d'informations

45,00

Piezo

200 mm

20 mm

33 mm

Ø 1,6 mm

Ø 3,5 mm

Ø 4,5 mm

Ø 5 mm

30 mm

95 mm

95 mm

Ø 40 mm

ISO BUTAN

960.1160 Micro set de soudure

i **283**
Plus d'informations

255,00

220 mm

Ø 0,5 - 6 mm
Ø 0,5 - 6 mm
Ø 0,5 - 10 mm
Ø 6,50 / 5,41 / 1,72 mm
Ø 0,5 - 4 mm
Ø 1,0 - 3,2 mm

115.1400

i **1**
Plus d'informations

6,00

143 mm

118.0013

i **1**
Plus d'informations

à partir de **5,00**

EG II

A 16 mm B 19 mm C 25 mm D 25 mm

	Produit	Longueur	Largeur	Prix
A	300.0113	3 m	16 mm	5,00 CHF
B	300.0114	5 m	19 mm	6,00 CHF
C	300.0115	5 m	25 mm	8,00 CHF
D	300.0116	8 m	25 mm	9,00 CHF

i **5**
Plus d'informations

Réglage de la température :
1°50°C / 2°100°C / 3°200°C /
4°350°C / 5°550°C / 6°650°C

260 mm

1 2 3 4 5 6

1 max. 450°C
2 max. 650°C

Utilisations : Pour décaper de vieilles peintures, étamer, contracter les gaines thermorétractables, souder ou plier le PVC, sécher...

45,00

960.1190

i **1**
Plus d'informations

IP 34

15 + 1 m

3x 1,5 mm²

230 V
50 Hz

1000/3000 W

10 A

180°

203,00

150.4217

i **12**
Plus d'informations

15,00

145 mm

5,0 x 1,0 mm
5,0 x 1,0 mm
3,0 mm
3,0 mm
5,0 mm
5,0 mm
3,0 mm
2,0 mm
2,0 mm
5,0 mm
5,0 mm
5,0 mm

140.3050

i **5**
Plus d'informations

45,00

200 mm

140.3000

i **1**
Plus d'informations

138 x 69 x 31 mm 342 9 V Data Hold

30,00

69 mm 138 mm

150.1495

i **1**
Plus d'informations

3 - 48 V

140 mm

18,00

550.1503 **Testeur de polarité et de courant 3 - 48 V**

i **1**
Plus d'informations

125 mm

6 - 24 V

8,00

550.1504 **Lampe/testeur 6 - 24 V**

i **1**
Plus d'informations

AUTOMATIC
DIGITAL MULTIMETER

143 x 70 x 16 mm 119 AAA Data Hold

16 mm

143 mm

70 mm

75,00

150.1765

Non. La description

- Bouton d'alimentation
- Commutateur de fonction
- Interrupteur capacitif
- Interrupteur d'éclairage
- Affichage LCD
- Zone du capteur PCI
- Fils d'essai

Symbole	La description
	Tension continue
	Tension alternative
	Indicateur de mise hors tension automatique
	Indicateur de batterie faible
	Mode diodes
	Passage
	Capacité
	Rapport du wattmètre
HOLD	Fonction de maintien des données
V, mV	Unité de tension : volt, millivolt
mF, µF, nF	Unité de capacité
MΩ, KΩ, Ω	Unité de résistance
NCV	Induction de tension sans contact
Live	Tester les lignes sous tension
KHz, Hz	Unité de fréquence
°C/°F	Celsius/Fahrenheit

USB-A USB-C

NCV

3 COLOUR ANALOG BAR

BUZZER ALARM

i **3**
Plus d'informations

210 x 88 x 44 mm
655
9 V
Data Hold

53,00

27,0 mm

Pour câble de diamètre maximal 29 mm

150.0925

i **1**
Plus d'informations

Pour courant alternatif ou continu

AC	6 - 50 - 120 - 230 - 400 V
DC	6 - 50 - 120 - 230 - 400 V

36,00

550.1501

CLÉ UNIVERSELLE POUR ARMOIRE ÉLECTRIQUE

i **1**
Plus d'informations

MINI

42 mm

- 6 - 7 - 8 mm
- 9 mm
- 3 - 5 mm
- PH 2
- 7 mm

26,00

130.1010

i **1**
Plus d'informations

71 mm

- 6 - 7 - 8 mm
- 9 mm
- 3 - 5 mm
- PH 2
- 7 mm

27,00

130.1015

i **1**
Plus d'informations

61 mm

- 5 - 7 - 8 mm
- 9 - 10 mm
- 4 - 10 mm
- PH 2
- 7 mm

27,00

130.1020

Tir fil

à partir de **8,00**

10 mètres 20 mètres

A	150.0960		1	Ø 3,0 mm 10 m	8,00 CHF
B	150.0970		1	Ø 4,0 mm 20 m	15,00 CHF

i **1**
Plus d'informations

53,00

Ø 3,0 mm

30 mètres

Aide à l'insertion de câbles

115.1113

i  **1**
Plus d'informations

35,00



- Mesure intermédiaire
- Rail de mesure en mm et en pouces
- Graduation de filetage

300.0510

i  **1**
Plus d'informations

38,00



+/- 0,03 mm

- Vis de blocage et finesse de réglage
- Pour mesure intérieure, extérieure et de profondeur

300.0532

i  **1**
Plus d'informations

THERMOMÈTRE LASER, -38° À 520°





75,00

AAA AAA

150.3040

i  **4**
Plus d'informations

86,00



WATERLINE

550.1290 Réfractomètre - Appareil de contrôle du liquide de batterie et liquide de refroidissement

i  **4**
Plus d'informations

Adblue®  

102,00



550.1285 Réfractomètre - Appareil de contrôle optique pour liquide de batteries, liquide de refroidissement et additifs AdBlue®

i  **4**
Plus d'informations

30,00

11 x 115 mm
15 x 185 mm
18 x 320 mm
18 x 470 mm

911.8100 Jeu de pinces leviers



i  **4**
Plus d'informations

XL

900 mm
600 mm

0°
45°
75°
90°

270,00

911.8410 Jeu de leviers



i  **22**
Plus d'informations

700.1200 Coffret d'extracteurs hydrauliques universels, deux et trois griffes

- Risque minime de ripage par fermeture automatique des bras
- 8 variantes d'extracteurs possibles
- Vis de force extrêmement robuste avec filetage durci
- Limite la consommation d'énergie
- En acier spécial

458,00

10 t, AG 1.1/2" x 16G

20 - 35 - 85 mm
235 mm
185 mm
225 mm
170 mm
120 mm
Ø max. 100 mm



i  **13**
Plus d'informations

NOUVEAU **POUR LES CAS D'URGENCE**

120,00

0% ✓ 85% ✓

Pour desserrer et retirer des écrous et vis grippés avec des têtes abîmées ou émoussées jusqu'à 85%

Y compris
3/8" 1/2"

913.3930 8 - 9 - 10 11 - 12 - 13 - 14 - 15 - 16 - 17 - 18 - 19 mm **3/8"**

i  **7**
Plus d'informations

135,00

Oeil coudé à 45°

517.1555 6x7 - 8x9 - 10x11 - 12x13 - 14x15 - 16x17 - 18x19 mm



i  **6**
Plus d'informations

- Pour boulons M3 à M18
- Permet de retirer des boulons et des écrous varrachés
- Spirale conique
- Dans son coffret robuste en matière plastique

26,00

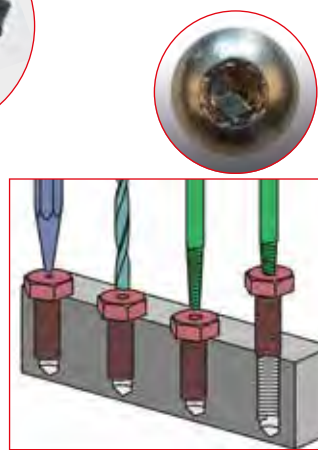





150.1330 Jeu d'extracteurs de goujons

i  **34**
Plus d'informations

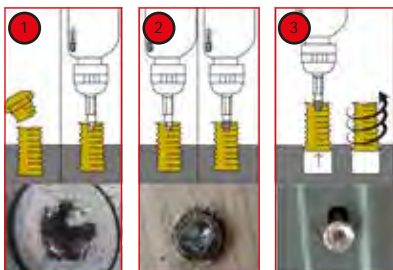
TORION power

68,00



9 x		TE10 - TE15 - TE20 - TE25 - TE27 - TE30 - TE40 - TE50 - TE55
9 x		1,5 - 2 - 2,5 - 3 - 4 - 5 - 6 - 8 - 10 mm
7 x		1,5 - 2 - 2,5 - 3 - 4 - 5 - 6 mm
7 x		T10 - T15 - T20 - T25 - T27 - T30 - T40

150.7060    1/4" + 10 mm Jeu d'extracteurs de vis Torx et à 6 pans

i  **25**
Plus d'informations

Jeu d'extracteurs

- Assortiment hétéroclite
- Pour retirer les écrous et les boulons arrachés
- Pas de dégât sur le filetage
- Ecartement minime grâce au profil spécial

Führungshülse drill guide	Hülse Innen- Ø mm guide	vorböhren Ø mm pre-drilling	aufbohren re-drilling	Stift pin	Art.Nr. Stift No. Pin	Mutter D nut D	Art.Nr. Mutter nut D	Stift + Mutter pin + nut
150.0501	4,0 / 3,2	3,2	-	3,2	150.0521	SW 10	150.0511	150.0511S
150.0502	4,8 / 3,2	3,2	-	3,2	150.0521	SW 10	150.0511	150.0511S
150.0503	4,8 / 3,2	3,2	4,8	4,8	150.0522	SW 11	150.0512	150.0512S
150.0504	4,8 / 3,2	3,2	4,8	4,8	150.0522	SW 11	150.0512	150.0512S
150.0505	6,0 / 4,8	4,8	6,4	6,4	150.0523	SW 13	150.0513	150.0513S
150.0506	7,0 / 4,8	4,8	6,4	6,4	150.0523	SW 13	150.0513	150.0513S
150.0507	7,0 / 4,8	4,8	8,0	8,0	150.0524	SW 14	150.0514	150.0514S
150.0508	7,0 / 4,8	4,8	8,7	8,7	150.0525	SW 17	150.0515	150.0515S
150.0509	9,0 / 6,5	6,4	8,7	8,7	150.0525	SW 17	150.0515	150.0515S
150.0510	9,5 / 6,5	6,4	8,7	8,7	150.0525	SW 17	150.0515	150.0515S

60,00

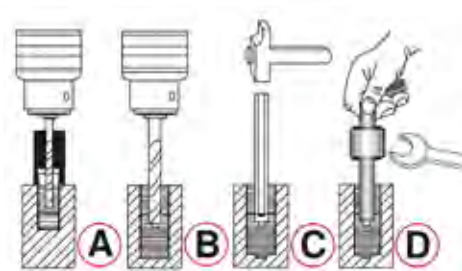

150.1305 M5 - M6 - M8 - M10 - M12 - M14 - M16



Plus d'informations

Coffret de dégoujonneuses à rouleaux

75,00

- Entraînement 6 pans, 21,0 mm
- Avec fonction serrage à droite et à gauche
- Très bonne tenue grâce à trois rouleaux
- Vissage et dévissage des goujons sans nécessité de contre-écrou
- Egalement adaptée aux goujons longs grâce au perçage traversant



M5 M6 M7 M8 M10 M12 M14



152.1101 M5 - M6 - M7 - M8 - M10 - M12 - M14



Plus d'informations

Coffret de tarauds et filières HSS Co



- Coffret universel
- Tarauds à prise droite
- Avec tourne à gauche et porte-filières réglables
- Livré avec jauge à filetage et tournevis fente
- Alliage au Cobalt haute performance

IL NE MANQUE DE RIEN



33 x		M3 - M4 - M5 - M6 - M8 - M10 - M12 M14 - M15 - M18 - M20
11 x		M3 - M4 - M5 - M6 - M8 - M10 - M12 M14 - M15 - M18 - M20
6 x		M3-M4 - M4,5-M6 - M7-M9 - M10-M11 - M12-M14 - M16-M20
2 x		M1-M10 - M5-M20

750,00

331.0754



Plus d'informations

TOUT LE MONDE AIME LES PORTER !

38,00



EN388



4131X

Microfibres

	Taille	Contenu
310.0490	7	12 paires
310.0491	8	12 paires
310.0470	9	12 paires
310.0475	10	12 paires
310.0480	11	12 paires



Plus d'informations

6,00



310.0120

FLAME DESIGN

Plus d'informations





75,00

310.0155

STEEL DESIGN



Plus d'informations





75,00

310.0195

	
EN 379 1/1/1/2	EN 175
Données techniques :	
Teinte variable :	Réglable selon DIN 9-13 Réglage standard : DIN 4
Temps de réponse :	1/25.000 s Temps de réponse 0,2 - 0,8 seconde (réglable)
Protection UV / IR :	Selon EN169 / jusqu'à DIN 16
Température d'utilisation :	-5°C à +55°C
Température de stockage :	-20°C à +70°C
Alimentation :	Par cellules solaires
Hauteur :	220 mm
Largeur :	200 mm
Longueur :	295 mm
Poids :	480 g
Dimension du coffret :	110 x 90 x 9 mm
Fenêtre :	92 x 42 mm

Pulvérisateur à pompe universel

Plus d'informations

- En Polyéthylène de grande qualité
- Pour différents produits chimiques comme les produits de nettoyage, de lavage et dissolvants...
- Ne convient pas pour les nettoyeurs de freins
- Tête de pulvérisateur en laiton, réglable et verrouillable
- Joints en Viton®
- Utile pour les travaux effectués au-dessus de la tête





à partir de 23,00

150.8251	1 L	23,00 CHF
150.8252	2 L	30,00 CHF

0,25 L

max. 8 bar (116 psi)

60°C / 140°F

115 mm

NOUVEAU

0,25 L

Aluminium

75,00

150.8272

Spécialement destiné au nettoyant de freins





i  **16**
Plus d'informations

EVOLUTION SERIES

Manche porte-lames double-corps

- Pour le nettoyage des adhésifs, restes de peinture et de colle
- Changement de lame simple avec la molette
- Coffret de rangement pratique pour les lames
- Différentes lames adaptées à tout type de travail
- Grattoir avec poignée bi-composant

Lames droites: 907.2202, 907.2203, 907.2204, 907.2205, 907.2206

NOUVEAU

5x  12 mm
5x  16 mm
5x  20 mm

 145 mm

20,00

907.2255

i  **27**
Plus d'informations

Jeu de grattoirs et cutters

5x  12 mm
5x  16 mm
5x  16 mm
5x  20 mm

145 mm

 145 mm

 145 mm

30,00

907.2200

Grattoir à lame type rasoir

A  110 mm

B  145 mm

à partir de **6,00**

A	907.2240			1	110 x 39 mm	6,00 CHF
B	907.2242			1	145 x 40 mm	8,00 CHF

Couteau avec pochette

A  190 mm

B  220 mm

à partir de **17,00**

A	907.2105			1	190 x 25 mm	17,00 CHF
B	907.2190			1	220 x 28 mm	18,00 CHF

i  **2**
Plus d'informations

23,00

155 mm

97 mm

+







907.2172 **Jeu de couteaux de poche**

i  **3**
Plus d'informations

60,00

250 mm

+



118.0050 **Jeu de cisailles à tôles**

Kit vidéoscope Wi-Fi avec capteur de caméra HD avant Ø 5,5 mm 0°

Plus d'informations

HD

WiFi

Ø 5,5 mm

Ø 5,5 mm

3500 mm

IP68

60,00

550.7560

EXTEND YOUR EYE

à partir de **360,00**

HD

6 mini-LEDs et variateur de lumière

Ø

0° 90°

1500 mAh Li-polymer

Ø 6,0 mm

Ø 4,5 mm

1000 mm

Raccord de sonde

3,5"

USB 2.0

microSD

Aimant

Aimant

Crochets

IP 67

AVI 1280 x 720

JPG

150 mm

-10°/+60°C

A	550.7500	5	6,0 mm	0° + 90°	360,00 CHF
B	550.7530	7	4,5 mm	0° + 90°	450,00 CHF



i  **3**
Plus d'informations



Ø
3,9 mm

6 mini-LEDs
et variateur
de lumière

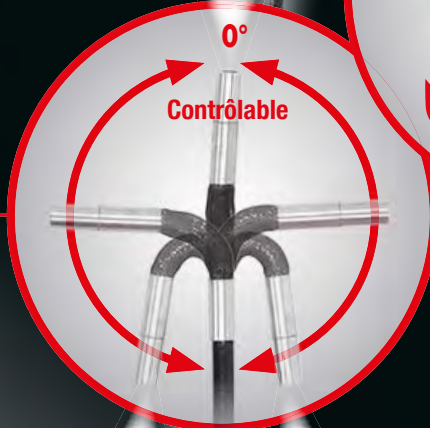

Raccord de sonde



3000 mAh
Li-polymer

IP 67

AVI
1280 x 720

JPG

150 mm

-10°/+60°C

NOUVEAU

675,00

+ 32 GB

550.7550 Set vidéoscope HD avec sonde de caméra frontale HD 180° et 0° Ø 3,9 mm, gaine flexible en PVC





Ø 12 - 35 MM



104.5060

Inox

Steel

Coupe-tubes à cliquet



60,00



Ø 28 - 67 MM



104.5050

Inox

Steel

Coupe-tubes à cliquet



195,00



116.1050

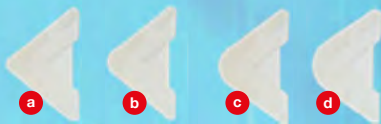

FUGENFIX[®]

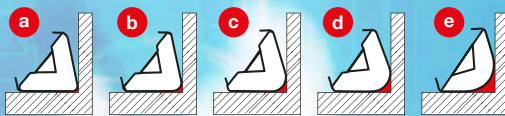

12,00

Jeu de spatules et grattoirs FUGENFIX



903.3300

Coffret de filières à main

3/8"
1/2"
3/4"
1"
1.1/4"

120,00



116.2000



87,00

Ventilfix

130.3000

1/2"

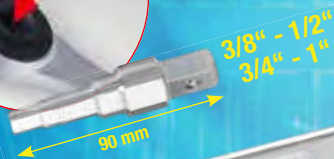

30,00

Clé de montage étagée + cliquet

903.5902

- Température de la flamme env. 1700°C
- Température de travail env. 650°C
- Etamage jusqu'à max. Ø 22 mm
- Livré sans cartouche de gaz
- A utiliser uniquement avec des brûleurs de haute qualité
- Corps du chalumeau en matière synthétique



38,00

Chalumeau propane avec piezo

907.2113

Scie japonaise, double denture



17x pro 2,5cm

8x pro 2,5cm

325 mm

27,00



850.0300

Sac à bandoulière SMARTBAG

111,00

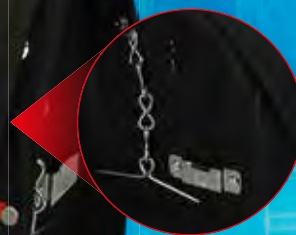

NOUVEAU



Structure compacte et robuste :

Grâce à des plastiques de haute qualité et à des vissages solides, la batterie offre une excellente protection contre les contraintes mécaniques.



Système de batterie 18 V eMONSTER

Le puissant système de batterie 18 V eMONSTER réunit une série d'outils électriques professionnels sur batterie. Tous les appareils peuvent être utilisés avec un système de batterie. La gamme est vaste et s'enrichit constamment. Chaque nouvel appareil peut également être utilisé avec ce système de batterie. Vous pouvez ainsi utiliser ce système de batterie pendant de nombreuses années et l'étendre avec des appareils sur batterie 18 V eMONSTER de la même famille.



Dissipation de la chaleur :

Grâce à la structure nervurée, la chaleur est guidée vers l'air ambiant comme dans un radiateur.



Refroidissement actif par air :

(Uniquement sur le chargeur rapide 8,0 Ah). Le ventilateur intégré du chargeur rapide 8,0 Ah fournit de l'air frais en continu pendant le processus de charge afin de réduire le plus possible la chaleur générée dans la batterie et le chargeur. Ce processus de charge délicat permet d'augmenter considérablement la durée de vie de la batterie.



Disposition des cellules optimisée :

Grâce à la structure tubulaire, les différentes cellules sont poussées dans le plastique dissipateur de chaleur. Il en résulte un contact solide entre la cellule et le plastique dissipateur de chaleur. Il n'y a plus de couche d'air isolante qui réduirait la dissipation de la chaleur.



Protection supplémentaire pour une longue durée de vie de la batterie :

Protection contre les surtensions :

- Protection contre les sources de tension excessivement élevées

Protection contre les basses tensions :

- Protection contre les décharges profondes en fonctionnement

Gestion de la température :

- Interaction entre l'appareil et la batterie afin d'éviter toute surcharge de la batterie





4 Jeu d'embouts eMONSTER pour perceuse-visseuse



4 Jeu d'embouts eMONSTER pour perceuse-visseuse à percussion

MINI

2 vitesses

150 mm

190 mm

LED

240,00

Couple maximum : 40 Nm

Entraînement : Mandrin à serrage rapide de 10 mm

Y COMPRIS

Tension de batterie: 18,0 V

Courant de charge max. : 3 A

Tension de batterie: 18,0 V

Technologie de batterie : Lithium-Ion

Capacité de la batterie: 2,0 Ah

Livraison avec deux batteries 2,0 Ah et un chargeur rapide 3 A

2 vitesses

195 mm

195 mm

LED

285,00

Couple maximum : 60 Nm

Entraînement : Mandrin à serrage rapide Röhm en métal de 13 mm



9 Jeu d'embouts 1/2" eMONSTER pour visseuse à percussion



4 Jeu de meuleuses d'angle eMONSTER

215 mm

190 mm

Présélection du couple réglable sur 3 niveaux

Arrêt de rotation

15 mm, 17 mm, 19 mm, 21 mm, 22 mm

405,00

Couple maximal de desserrage : 690 Nm

Entraînement : 1/2"

Y COMPRIS

Tension de batterie: 18,0 V

Courant de charge max. : 8 A

Tension de batterie: 18,0 V

Technologie de batterie : Lithium-Ion

Capacité de la batterie: 4,0 Ah

Livraison avec deux batteries 4,0 Ah et un chargeur rapide 8 A

230 mm

Ø 125 mm

320 mm

Clé de serrage dans la poignée latérale

6 niveaux de vitesse

1, 2, 3, 4, 5, 6

Vitesse de rotation : 9000 Tr/min

Vibrations : < 4,831 m/s²

3,371 m/s²

450,00

515.6200

i Plus d'informations

NOUVEAU

Set d'embouts TORSIONpower 1/4" eMONSTER, 32 pcs

15,00

1 x		1/4"
1 x		1/4"
4 x		3 - 4 - 5 - 6 mm
4 x		PH1 - 2 x PH2 - PH3
4 x		PZ1 - 2 x PZ2 - PZ3
4 x		3 - 4 - 5 - 6 mm
7 x		T10 - T15 - T20 - T25 - T27 - T30 - T40
7 x		TB10 - TB15 - TB20 - TB25 - TB27 - TB30 - TB40

+30%

Peut être introduite et fixée dans les appareils 18 V eMONSTER en tant que batterie factice

515.6932

ICI, C'EST COUP POUR COUP !

1.390 N·m

1/2"

90 mm

165 mm

515.1150

1  **300,00**

1.390 N·m

1/2"

95 mm

190 mm

515.1270

2  **225,00**

1.084 N·m

1/2"

115 mm

180 mm

515.1315

3  **105,00**

1.600 N·m

1/2"

170 mm

188 mm

515.1200

4  **105,00**

2.000 N·m

3/4"

170 mm

185 mm

515.3400

5  **188,00**

1.690 N·m

1/2" 3/4"

175 mm

200 mm

515.1210

6  **225,00**

7  **285,00**

3.405 N·m

3/4" 1"

40 mm

350 mm

515.3250

9  **1275,00**

11  **1275,00**

3.405 N·m

3/4" 1"

195 mm

350 mm

515.3260

10  **1358,00**

12  **1358,00**

													
		Nm	U/min	m/s ²	dB(A)	dB(A)	U/min	PT				Kg	
1	515.1150	1/2"	1390	10.000	<9,18	102,0	113,0	135	1/4"	-	✓	-	1,08
2	515.1270	1/2"	1390	10.000	<9,18	102,0	113,0	135	1/4"	-	✓	✓	1,3
3	515.1315	1/2"	1084	9000	<10,36	106,0	115,0	169	1/4"	-	✓	-	1,2
4	515.1200	1/2"	1600	8500	<17,5	89,9	100,9	169	1/4"	✓	-	-	2,1
5	515.3400	3/4"	2000	8500	<17,25	91,0	100,9	196	1/4"	✓	✓	-	2,2
6	515.1210	1/2"	1690	7930	<17,9	87,0	98,0	178	1/4"	✓	✓	-	2,1
7	515.3785	3/4"	1690	7930	<13,56	88,0	104,0	178	1/4"	✓	✓	-	2,2
8	512.0002	1/2"	2300	8500	<8,69	99,7	110,9	244	1/4"	✓	✓	✓	1,6
9	515.3250	3/4"	3405	6200	<12,57	115,5	104,5	283	1/2"	✓	✓	-	6,7
10	515.3260	3/4"	3405	6200	<12,88	115,5	104,5	283	1/2"	✓	✓	-	7,7
11	515.3270	1"	3405	6200	<12,57	115,5	104,5	283	1/2"	✓	✓	-	6,7
12	515.3280	1"	3405	6200	<12,88	115,5	104,5	283	1/2"	✓	✓	-	7,8

 Mécanisme de frappe à double marteau haute performance

 Outil de percussion haute performance Jumbo

 Technologie BITURBO

Tous les prix en CHF, hors TVA, sont valables jusqu'au 30/09/2024

AVEC BI-TURBO, COUPLE DE 2 300 NM ATTEINT EN ~ 15 SECONDES SEULEMENT !

170 mm

185 mm



ROCKET II

2300

VB BITURBO

DEUX CONDUITS D'AIR, UNE PUISSANCE DOUBLÉE !

Deux conduits d'air alimentent le moteur BiTurbo puissant à 8 lamelles. Vous pouvez vous représenter ce fonctionnement comme sur une voiture : le turbo s'enclenche en premier, puis le 2e groupe moteur se met en route et garantit un gain de puissance supplémentaire.



Mécanisme de frappe à double marteau haute performance



BITURBO



VB = HUIT PALES DE ROTOR AU LIEU DE 6



512.0002



210,00

SORTIE D'AIR BIEN PENSÉE



1/4" PT	8.500 rpm	max. 2300 Nm	max. 851 Nm	max. 1256 Nm	244 L/min	6,3 bar	3,8" - 10,0 mm	1,6 kg	<8,69 m/s ²	110,9 dbA	99,7 dbA	max. M 16
---------	-----------	--------------	-------------	--------------	-----------	---------	----------------	--------	------------------------	-----------	----------	-----------

Tous les prix en CHF, hors TVA, sont valables jusqu'au 30/09/2024

2E GÉNÉRATION - 2E GÉNÉRATION - 2E GÉNÉRATION - 2E GÉNÉRATION - 2E GÉNÉRATION

i  **1**
Plus d'informations

**Débit de graisse :
Une dose par pression**

200 mm

400 g

400 mm

100,00

515.3900 Pompe à graisse pneumatique pour débit de graisse par élévation

i  **1**
Plus d'informations

à partir de **38,00**

PU ✓

515.3330	6,0 mm	G1/4" AG	8,0 m	38,00 CHF
515.3335	8,0 mm	G1/4" AG	15,0 m	53,00 CHF
515.3340	10,0 mm	G3/8" AG	15,0 m	60,00 CHF

i  **1**
Plus d'informations

15,00

Réglable

100 mm

515.1901 Soufflette pistolet avec réglage de pression

i  **3**
Plus d'informations

30,00

510 mm

330 mm

95 mm

515.1921 Jeu de 3 soufflettes

Enrouleur avec tuyau

15 m

1,5 m

180°

STOP

i  **1**
Plus d'informations

180,00

➔ **Ø 10 MM X 15 M**

A

Données techniques :

Diamètre intérieur du tuyau : 10,0 mm
Pression maximale : 20,0 bar
Filetage de raccord : 1/4"

515.3440

i  **1**
Plus d'informations

270,00

➔ **Ø 13 MM X 15 M**

B

Données techniques :

Diamètre intérieur du tuyau : 13,0 mm
Pression maximale : 20,0 bar
Filetage de raccord : 3/8"

515.3445

i 1
Plus d'informations

à partir de
18,00

	↔		
A	500.8040	480 mm	18,00 CHF
B	500.8045	1.150 mm	60,00 CHF

i 1
Plus d'informations

1
75,00

500.8020

i 1
Plus d'informations

2
90,00

500.8030

i 1
Plus d'informations

RÉSISTANCE ÉLEVÉE, JUSQU'À 135 KG

3
105,00

500.8004

i 1
Plus d'informations

4
105,00

500.8011

i 1
Plus d'informations

6
150,00

500.8000

	1	2	3	4	5	6
Données techniques :	500.8020	500.8030	500.8004	500.8011	500.8090	500.8000
Couleur	Rouge	Rouge	Rouge	Rouge	Rouge	Rouge
Tissu	Tube en acier	Métal	Métal	Métal	Plastique	Métal
Nombre de roue de directions	4	5	5	6	6	6
Avec roues	✓	✓	✓	✓	✓	✓
Type de pneumatique	Matière plastique	Matière plastique	Caoutchouc	Matière plastique	Matière plastique	Matière plastique
Capitonné	✓	✓	✓	✓	✗	✓
Hauteur réglable	✗	✓	✓	✓	✗	✓
Contenu	1	1	1	1	1	1
Longueur totale L en mm	365,0 mm	370,0 mm	360,0 mm	1040,0 mm	1030,0 mm	1200,0 mm
Largeur B	360,0 mm	370,0 mm	360,0 mm	490,0 mm	480,0 mm	420,0 mm
Hauteur H	360,0 mm	420,0 - 540,0 mm	463,0 - 580,0 mm	85,0 - 400,0 mm	115,0 mm	145,0 - 510,0 mm
Charge admise kg	90 kg	90 kg	135 kg	90 kg	120 kg	90 kg

i 1
Plus d'informations

LE PLUS LÉGER

5
102,00

500.8090

i  **3**
Plus d'informations

Parfaitement flexible

NOUVEAU

68,00

500.8077 Jeu de compartiments à outils en silicone

1 53 x 29,5 x 3,2 cm

2 25,5 x 23,3 x 2,4 cm

3 27,5 x 14,5 x 2,4 cm

i  **1**
Plus d'informations

- Profil antidérapant
- Grande plateforme stable
- Pieds avec protection en PVC

960 mm

300 mm

495 mm

150,00

800.0960 Marche-pied en aluminium

TESTÉ PAR LE  POUR VOTRE SÉCURITÉ !

i  **1**
Plus d'informations

- Tôle aluminium striée sur les marches
- Tout basculement est impossible
- Pliable pour un gain de place

600 mm

440 mm

620 mm

83,00

800.0965 Escabeau en aluminium

TESTÉ PAR LE  POUR VOTRE SÉCURITÉ !





Plus d'informations

SURFACE DE TRAVAIL MAXIMALE

1800,00



865.0201
Etabli d'atelier professionnel XXL 1 porte et 3 tiroirs





Plus d'informations

PETIT ET GRAND À LA FOIS !



500.8100
Chariot utilitaire universel télescopique avec roues





Plus d'informations



Ø 440 mm



999.2000
Ventilateur d'atelier, 70 watts





Plus d'informations



360°
Pivotant

Etaux à mors parallèles

à partir de **249,00**



914.0004	120 mm	4"	249,00 CHF
914.0005	140 mm	5"	269,00 CHF
914.0006	160 mm	6"	285,00 CHF
914.0008	200 mm	8"	345,00 CHF

i **1**

Plus d'informations

max. 8 bar (116 PSI)

60° C / 140° F

1 Water
2 Detergent
3
4
5
Switch
Lock

Max. 40° C
Max.

30,00

150.8271 **Pulverisateur à mousse (vaporisateur)**

i **1**

Plus d'informations

350 mm

650 mm

128,00

500.8013 **Tabouret sur roulettes**

i **1**

Plus d'informations

6,3 bar / 96 L/min

92 dbA / 1/4" PT

60,00

145 mm

3/8" - Ø 10 mm

Aspirer

Souffler

60,00

515.5090 **Pistolet de soufflage et d'aspiration à air comprimé**

i **1**
Plus d'informations



Ø 90 mm 15 mm M8

9,00

515.1243 Disque de gommage



i **1**
Plus d'informations

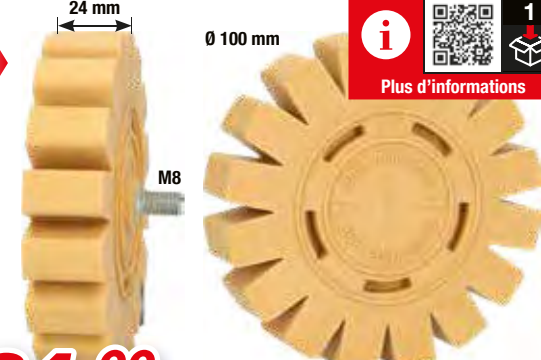

24 mm Ø 100 mm M8

24,00

515.1247 Disque de ponçage avec lamelles

i **6**
Plus d'informations

PRIX DU SET = 6x



45,00

515.1285



i **6**
Plus d'informations

PRIX DU SET = 6x



135,00

515.1366

i **1**
Plus d'informations





213,00

515.1980 Pistolet de nettoyage pneumatique

Réglable



360°
30°

Roulement à billes industriel



		<3.90 m/s² icon"/>

EN OPTION

i **1**
Plus d'informations



9,00

515.1983 Support de brosse

i **1**
Plus d'informations



9,00

515.1986 Pinceau à brosse

i **6**
Plus d'informations

45,00

510 mm

4 mm
8 mm
10 mm

4 mm
8 mm
10 mm

245 mm

140.2370 Jeu d'outils à dégraffer

i **11**
Plus d'informations

30,00

180 mm 200 mm 200 mm 200 mm 210 mm

160 mm 200 mm 200 mm 180 mm 200 mm 200 mm

911.8205 Jeu de pinces levier MASTER

i **1**
Plus d'informations

DC 12V 24V AC 100-240V 50/60 Hz

- Elimine les odeurs et désinfecte l'habitacle
- Arrêt automatique après 60 minutes sur le mode destructeur d'odeurs
- Nettoyage sans résidu garanti car n'utilise pas de produit chimique
- Ne laisse aucune trace même sur des surfaces sensibles
- Elimine moisissures, bactéries, champignons et acariens

173 mm

49 mm

122 mm

120,00

550.1183 Purificateur d'air plasma par ionisation

i **1**
Plus d'informations

- Convient parfaitement pour le nettoyage de tubes, tuyaux ou siphons étroits
- Utilisable des deux côtés
- Tige en Inox flexible
- Brosse en nylon

6,00 NOUVEAU

Ø 16 mm

Ø 22 mm

150.1762 Brosse de nettoyage flexible

i **7**
Plus d'informations

Ø 0 - 38 mm

Ø 0 - 48,5 mm

Ø 0 - 65 mm

Ø 0 - 30 mm

Ø 0 - 45 mm

Ø 0 - 45 mm

Ø 0 - 60 mm

120,00

115.1055 Coffret de pinces spéciales à collier

i **3**
Plus d'informations

15,00

Ø 15 mm Ø 30 mm Ø 60 mm

150 mm 180 mm 250 mm

115.5050

i **3**
Plus d'informations

Ø 35 mm

Ø 15 mm Ø 23 mm

155 mm 255 mm 165 mm

20,00

115.5055

i **1**
Plus d'informations

23,00

Pompe manuelle d'aspiration et de niveau

150.9221

i **1**
Plus d'informations

30,00

100 mm

Clé à douille spéciale 3/8" pour raccords à vis de tuyaux d'aspiration

150.2519

i **1**
Plus d'informations

30,00

12V 5A 60W
Richtung Direction
150.2620

PETROL DIESEL OIL

Pompe électrique d'aspiration et de transvasement d'huile

150.2620

i **1**
Plus d'informations

8,00

NOUVEAU

Douille amovible pour colliers de 30-45 mm et 60-80 mm

30 mm

Clé à douille spéciale 2-en-1 pour colliers profilés à 3 points

115.0915

i **1**
Plus d'informations

20,00

NOUVEAU

1/2"

108 mm

Outil de desserrage du bouchon de radiateur pour VAG

150.1919





25

Plus d'informations











0 - 2,5 bar

max. 76 cm

0 - 200 °C
0 - 400 °F

1600 mm



R123
R124



R123
R125



#1



#2



#3



M50 x 2,5



M42 x 3



M58 x 3



M62 x 3



M48 x 4



M45 x 3



M50 x 2,5



M60 x 4



M52 x 3



M48 x 2,5



M42 x 2,5



M50 x 3



M46 x 3



M34 x 2,5



75 mm



270,00

150.1930

**Coffret de diagnostic
pour système de refroidissement**





1

Plus d'informations

Raccord 7,2 mm sur 4,4 mm



NOUVEAU

7,2 mm

80 mm

4,4 mm

30,00



150.1936





1

Plus d'informations

Raccord 4,4 mm sur 7,2 mm



NOUVEAU

4,4 mm

74 mm

7,2 mm

38,00

150.1937

i  **8**
Plus d'informations

250 ml

150,00

EN OPTION À RACHETER

23,00

150.1914

150.1910 Coffret testeur de CO2

i  **3**
Plus d'informations

PARFAITEMENT FLEXIBLE

53 x 29,5 x 3,2 cm

1

2 25,5 x 23,3 x 2,4 cm

3 27,5 x 14,5 x 2,4 cm

NOUVEAU

68,00

500.8077 Jeu de compartiments à outils en silicone



2

Plus d'informations



38,⁰⁰

NOUVEAU



14 mm 180 mm

+



16 mm 215 mm

POUR MOTEURS FORD ECOBOOST 1,0 LITRE

POUR MOTEURS FORD ECOBOOST 1,5 LITRE





Jeu de douilles pour bougies d'allumage pour moteurs EcoBoost



2

Plus d'informations

M20 x 1.5 M22 x 1.5

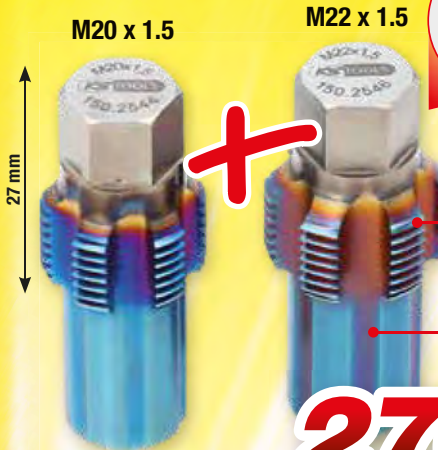

27 mm



13 mm

- Pour tarauder des filetages spéciaux rouillés et endommagés
- Parfait pour les capteurs NOX et de filtres à particules dans des installations d'échappement
- Avec 6 profils de coupe pour un centrage parfait
- Version particulièrement courte
- Avec rainures de nettoyage dans le boulon de guidage

Avec 6 profils de coupe pour un centrage parfait

Avec rainures de nettoyage dans le boulon de guidage

270,⁰⁰



Jeu de tarauds avec boulon de guidage pour capteurs

SOLUTION DE GÉNIE



1

Plus d'informations

Taraud avec boulon de guidage

• Pour tarauder des filetages spéciaux rouillés et endommagés





13 mm



A



B



C



D



E

Avec 6 profils de coupe pour un centrage parfait

Avec rainures de nettoyage dans le boulon de guidage

150,⁰⁰



Jeu de tarauds avec boulon de guidage pour capteurs

			L1	L2			
A	150.2541	Pour capteurs de température	M12 x 1,25	55 mm	33 mm	13 mm	150, ⁰⁰ CHF
B	150.2542	Pour capteurs de température	M14 x 1,5	45 mm	30 mm	13 mm	150, ⁰⁰ CHF
C	150.2543	Pour sondes lambda	M18 x 1,5	42 mm	27 mm	13 mm	150, ⁰⁰ CHF
D	150.2544	Pour capteurs de NOX	M20 x 1,5	50 mm	27 mm	13 mm	150, ⁰⁰ CHF
E	150.2546	Pour capteurs de filtres à particules	M22 x 1,5	50 mm	27 mm	13 mm	150, ⁰⁰ CHF

i  **1**
Plus d'informations

30,00



1 **2**

500.7505 Extracteur pour bobines d'allumage sur perche



i  **7**
Plus d'informations

POUR MOTEURS VAG ET OPEL

105,00



1 **2** **3** **4**
5 **6** **7**

500.7570 Jeu d'extracteurs de bobines d'allumage à poignée en T pour moteurs VAG et Opel



i  **7**
Plus d'informations

120 ml 120 ml



6x10
6x6
6x8
6x4
600 mm
Ø 6x9 mm

255,00

150.1900 Coffret de pompe à pression et dépression



i  **24**
Plus d'informations



75,00

700.1280 Kit de montage outils bagues d'étanchéité universelles et joints spi



i **1**
Plus d'informations

max. 165 mm

M 12 x 75 mm

30 mm

40-165 mm

60,00

150.3170 Extracteur universel de poulies de courroie à deux griffes Ø 40-165 mm

i **1**
Plus d'informations

NOUVEAU

1/4" 13 mm

Ø 3,0 mm

8 - 25 mm

- Pour serrer/desserrer le galet tendeur à courroie de distribution
- Utilisation universelle
- Carré d'entraînement intérieur d'après DIN 3120 / ISO 1174 avec encoche pour verrouillage par bille
- avec entraînement à six pans 13,0 mm
- Tête brunie

30,00

150.3046 Clé à ergots universelle pour galet tendeur à courroie de distribution, réglable

i **1**
Plus d'informations

Champ d'application : Citroën, Peugeot, Opel et Toyota Avec moteurs essence 1,0 et 1,2 (code moteur : ZMZ (EB0F / EBO) / HM01 (1PP) / HMV, HMZ (EB2) / HMZ (EB2 / EB2F) / HMT (EB2D) / HMU (EB2D) / HNZ (EB2DT) / HNY (EB2DTS) / HMV (EB2M) / HMY (EB2M) / B12XE (EB2F) / D12XE (EB2FA) / B12XHL (EB2DT) / D12XHL, F12XHL (EB2ADT) / B12XHT (EB2DTS) / D12XHT, F12XHT (EB2ADTS)

15,00

400.2118 Outil de contrôle de courroie de distribution pour PSA

i **1**
Plus d'informations

M 15 x 1,5 x 71 mm

17 mm

27 mm

70 mm

53,00

150.3130 Extracteur universel à trois griffes de poulie à courroie

i **22**
Plus d'informations

Petrol Diesel OIL

- Pour le montage et le démontage des colliers CLIC sur conduites d'essence, d'air, de climatisation et hydraulique
- Sans endommager les raccords, les conduites ou les flexibles
- Travail rapide et simple sur conduites d'essence
- Pour tous raccords sur véhicules européens, asiatiques et américaines

115.1260 Jeu d'extracteurs de cosses

75,00

5/16" 1/4" 5/16" 3/8" 3/8" 1/2" 5/8" 7/8"

3/8" 1/2" 5/8" 3/4" 5/16"

3/8" 1/2" 5/8"

3/4" 7/8" 5/16" x 3/8"

5/16"



Plus d'informations

IL PEUT ENCAISSER JUSQU'À 3 873 CHOCS PAR MINUTE !

NOUVEAU

- Avec 7 adaptateurs pour presque tous les injecteurs
- Effet de frappe très élevé (3 365 (6,3 bar) / 3 873 (8 bar) chocs par minute)
- Pour extraire les injecteurs bloqués dans la culasse
- Avec un adaptateur correspondant, l'extracteur est vissé à la buse d'injection grippée
- Faible encombrement grâce à une construction compacte



A B C



D



E F G H



230 mm

223 L/min	3/4"-19 mm	108,4 dbA
6,3 bar (90 psi)	71,9 m/s ²	6 mm
12 bar	119,4 dbA	M18 x 1,5

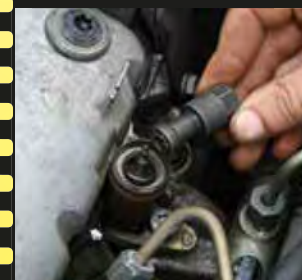
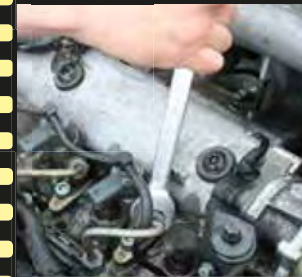

A	M25 x 1,0	Siemens
B	M20 x 1,0	Denso
C	M27 x 1,0	Siemens
D	M27/M17/10 mm	Bosch/Fiat/BMW/PSA/ Mercedes/Renault
E	M18 x 1,5	Adaptateurs
F	M17 x 1,0	Bosch/Mercedes
G	M16 x 1,0	Toyota
H	M14 x 1,5	Bosch/Delphi/BMW

**BOSCH
DENSO
DELPHI
SIEMENS**



...

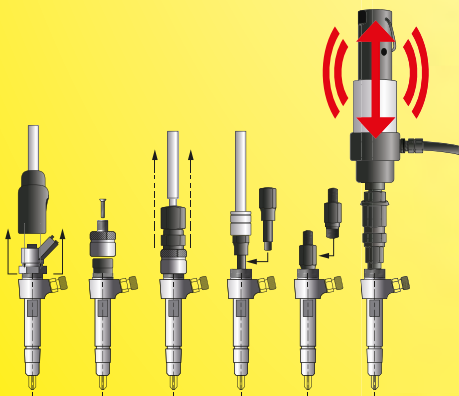

405,00

Set d'extracteur d'injecteurs à air comprimé

152.1130

6
Plus d'informations

285 - 875 mm

TÉLESCOPIQUE

150 - 675 mm

500g

200g

1000g

2000g

3000g

Ø 4 mm

Ø 13 mm

Ø 16 mm

Ø 19 mm

400 mm

510 mm

NOUVEAU

41,00

550.1090 **Jeu de miroirs d'inspection et d'aimants flexibles et télescopiques**

1
Plus d'informations

125 mm

6 - 24 V

8,00

550.1504 **Lampe/testeur 6 - 24 V**

1
Plus d'informations

18,00

3 - 48 V

Testeur de polarité et de courant

550.1503

2
Plus d'informations

195,00

25 m

6 - 24 V

Testeur

150.1655

2
Plus d'informations

1 Récepteur

2 Émetteur avec pince crocodile

90,00

150.3075 **Détecteur de court-circuits**





Plus d'informations







display
voltage current charging%
12V 24V 15.0 MODE

 **Charger la batterie**
 **Charge de maintien**
 **Réparation de la batterie**
 **Alimentation en courant continu**

12V
24V

Au choix : 12 ou 24 Volt

555,00

Capteur de température



Données techniques :

Capacité de la batterie :	12V: 75-500Ah - 24V: 45-250Ah
Plage de tension :	220-240V AC, 50/60HZ
Tension de charge :	14,4V - 25A (12V), 28,8V - 12,5A (24V)
Plage de fréquence :	50 Hz
Câble :	H05RN-F 2x1,0 mm ²

550.1745 Chargeur de batteries haute fréquence SMARTcharger 12V + 24V, 25A/12.5A







Plus d'informations



Pour presque toutes les batteries

Avec imprimante et 3 rouleaux de papier

552,00





MF

WET

AGM

VRLA

GEL

✓

Testeur digital 12V / 24V de batterie et de circuit de charge avec imprimante intégrée

550.1649

Données techniques :

Affichage :	Numérique
Plage de travail CA / MCA :	40-2.000 CCA
Plage de travail CCA :	40-2.000 CCA
Plage de travail DIN :	40-2.000 CCA
Plage de travail EN :	40-2.000 CCA
Plage de travail IEC :	40-2.000 CCA
Plage de travail JIS# :	40-2.000 CCA
Plage de travail SAE :	40-2.000 CCA
Température de fonctionnement :	0°C à +55°C
Plage de fréquence :	100 Hz
Plage de mesure :	9-36 V
Précision de mesure :	+/- 0,5 Megaohm
Plage de tension :	9-36 V





Plus d'informations



1400 A



Concept de sécurité intelligent pour éviter toute mauvaise manipulation :

Le commutateur de sécurité ne met les bornes sous tension que si :

- elles sont correctement raccordées (polarité)
- la connexion ne présente aucun risque de court-circuit
- la tension appliquée est adaptée
- la batterie du véhicule est en bon état



900,00











Booster à batterie 12 V + 24 V, 1400 A

550.1720

i 26
Plus d'informations

D'E **GS**
1000 V

3/8"

495,00

Valise d'outils isolés pour véhicules hybrides et électriques

117.1895

2 x		4 mm - 5,5 mm
2 x		PH1 - PH2
6 x		6 - 8 - 10 - 12 - 13 - 17 mm
1 x		185 mm
1 x		165 mm
1 x		3/8"
1 x		3/8": 200 mm
1 x		3/8": 125 mm
10 x		3/8": 8 - 10 - 11 - 12 - 13 - 14 - 16 - 17 - 19 - 22 mm
1 x		200 mm

i 43
Plus d'informations

D'E **GS**
1000 V

3/8"

848,00

Valise d'outils isolés pour véhicules hybrides et électriques

117.1890

4 x		2,5 - 3 - 3,5 - 4 mm
3 x		PH1 - PH2 - PH3
3 x		T20 - T25 - T30
1 x		210 mm
1 x		185 mm
1 x		165 mm
1 x		215 mm
1 x		165 mm
1 x		240 mm
2 x		10 - 25 mm
1 x		180 mm
1 x		3/8"
15 x		3/8": 6 - 7 - 8 - 9 - 10 - 11 - 12 - 13 - 14 - 16 - 17 - 18 - 19 - 20 - 22 mm
2 x		3/8": 150 - 250 mm
3 x		3/8": M8 - M10 - M12
1 x		Ø 200 mm
1 x		200 mm
1 x		500 m

i 18
Plus d'informations

D'E **GS**
1000 V

495,00

Jeu de clés à fourche avec gaine isolante

118.1500

18 x		7 - 8 - 9 - 10 - 11 - 12 - 13 - 14 - 15 - 16 - 17 - 18 - 19 - 20 - 21 - 22 - 23 - 24 mm
------	--	---

i 1
Plus d'informations

<44.500 V

270,00

Perche d'extraction isolée

150.0913

1.680 mm



Plus d'informations

LE KIT D'INITIATION À LA MOBILITE ELECTRIQUE

ecoLine



1

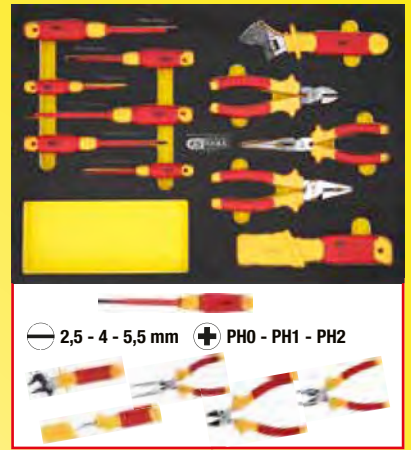

2

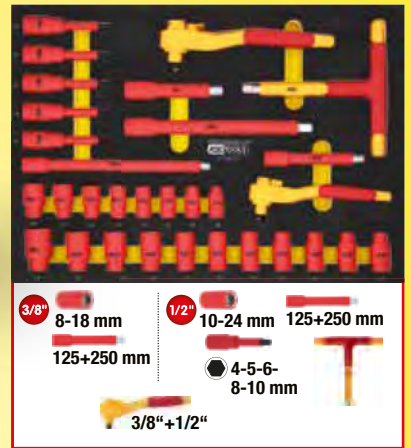

Perforation à quatre pans pour accessoires

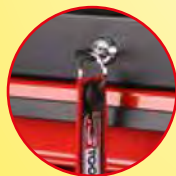

Fermeture grâce à la serrure à barillet intégrée



Plan de travail avec insert en mousse de 10 mm



Avec rappel de fermeture et fonction SOFT CLOSE



2 roues avec roulements Ø 125mm et freins

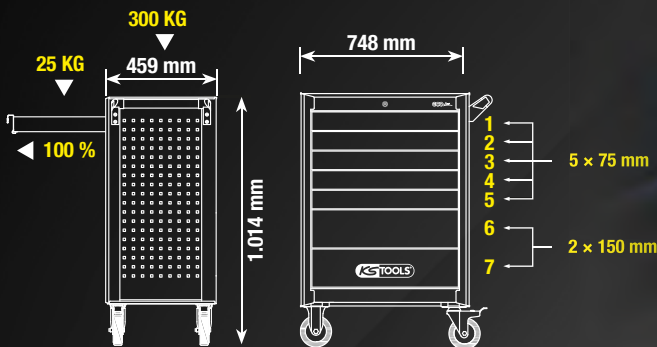

Chariot d'atelier ECOline avec 42 outils isolés pour véhicules électriques et hybrides

1949,00
42 OUTILS COMPRIS

117.6144

6449,00



Panneau de signalisation pour travaux sur véhicules hybrides et électriques



200 mm

917.3898

Panneau de signalisation pour travaux sur véhicules hybrides et électriques



Ø 200 mm

917.3897

Tapis isolant, 1000 mm, épaisseur 3,0 mm



117.3819

Sous-gants



117.1660

Gants de protection électrique avec revêtement isolant, taille 10, épaisseur 1, blancs



117.1664

Visière de protection pour électricien, classe 2



117.1796



117.6172

Jeu de douilles isolées 3/8"+1/2" avec clé dynamométrique dans une garniture en mousse, 72 pcs



117.6133

Jeu de douilles isolées dans une garniture en mousse, 33 pcs

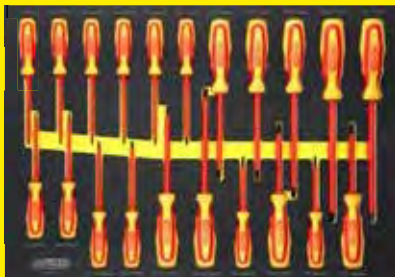

117.6121

Jeu de tournevis ERGOTORQUE VDE dans une garniture en mousse, 21 pcs



117.6117

Jeu de pinces ERGOTORQUE VDE dans une garniture en mousse, 17 pcs

117.6155

Chariot d'atelier PERFORMANCEplus e10 avec 164 outils isolés pour véhicules électriques et hybrides

15,00



117.0223

Panneau de toit avec symbole d'éclair et aimant



15,00

117.0222

Panneau de toit avec
symbole d'éclair et ventouse



23,00

117.0226

Panneau avec symbole
d'éclair



105,00

117.1550

Jeu de piquets
avec chaîne

2x

210,00

117.1545

2 x Barrière extensible
plastique



Vous trouverez le catalogue
d'électromobilité de 188 pages
sur www.kstools.com

i  **4**
Plus d'informations

Ø 22,0 - 28,0 mm

Ø 15,0 - 21,0 mm

Ø 17,0 - 25,0 mm

Jeu d'outils de centrage pour embrayage

14,00

150.2180 Ø 15,0 - 28,0 mm



i  **11**
Plus d'informations

150 kg

310 mm

450 mm

300 mm

593,00

160.0910 **Jeu de supports de boîte de vitesses universel**



i  **3**
Plus d'informations

- 1 L'outil de remplissage A pour monter et démonter
- 2 Vidanger l'huile, faible débit
- 3 Vérifier le niveau de remplissage
- 4 Vidanger l'huile, plein débit

38,00

9G-TRONIC

56 mm

20 mm

74,5 mm

9 mm

28,5 mm

39,5 mm

9 mm

152 mm

48 mm

150.9695



160.0910 **Jeu de supports de boîte de vitesses universel**



i  **24**
Plus d'informations

LE PLUS COMPLET !

150.9261		1/8-27 NPT Ford
150.9262		BMW, Honda, Nissan etc.
150.9263		VAG
150.9264		VAG, Porsche
150.9265		M10 x 1.0 VAG, Mini Cooper
150.9267		M12 x 1.5 Mercedes
150.9268		M24 x 1.5 VAG DSG
150.9269		M22 x 1.5 VAG CVT
150.9271		M18 x 1.5 Skoda
150.9272		M30 x 1.5 VAG, Skoda
150.9273		Universal Flexible 300 mm, Honda, Hyundai, Kia, etc.
150.9274		5/16-24 (UNF) Volvo
150.9276		M18 x 1,5 Toyota / Lexus
150.9277		M8 x 1,0 Nissan / Infinity
150.9278		ATF-Adapter V.W, Passat
150.9562		Nissan Juke M12 x 1,25
150.9563		Mini Cooper M14 x 1,5
150.9564		Nissan M10 x 1,5
150.9566		GM M12 x 1,75
150.9567		Mercedes 725-9G
150.9102		VAG 7 DSG
150.9103		VAG 7 DSG
150.9104		VAG 7 DSG

300,00

JEU DE 23 ADAPTATEURS INCLUS

NOUVEAU

150.9105 **Système de remplissage universel de boîte de vitesses incl. 23 pcs jeu d'adaptateurs**



i  **4**
Plus d'informations



168,00



Ø 30 mm

160.0195 Support de jambe de suspension
McPherson pour levier de vérins de

i  **7**
Plus d'informations



6 mm

150,00



150.9545 Outils de montage à compresseur
de ressort pour amortisseurs

TESTÉ PAR LE  **POUR VOTRE SÉCURITÉ !**

i  **6**
Plus d'informations

Pour 90% des VL les plus courants



Ø 140 - 195 mm

Ø 80 - 160 mm

CHARGE max 26000 N



678,00

- Pour le montage et le démontage des suspensions MC Pherson
- Nécessaire pour le changement d'amortisseur ou de ressort à visser
- Pour 90% des VL les plus courants
- Alternative économique par rapport aux compresseurs de ressorts standards
- adapté aux ressorts coniques et ronds
- Avec certification TÜV

500.8400 Kit de compresseurs de ressorts universel

Données techniques :	
Pression maximale :	2600 kg
Ouverture maximale :	355,0
Capacité de ressort :	80,0 - 195,0 mm

TESTÉ PAR LE



POUR VOTRE SÉCURITÉ !



11

Plus d'informations



1/2" x 1/2", 100 Nm



Ø 30 mm

560,00



TUV SUD



Ø 90 - 140 mm

500.8765 Jeu de compresseurs de ressorts télescopiques pour ressorts intérieurs pour Audi et Seat

POUR UNE EXTENSION



2

Plus d'informations

Ø 95-110 mm

POUR COMPRESSEUR DE RESSORT
500.8755 + 500.8765

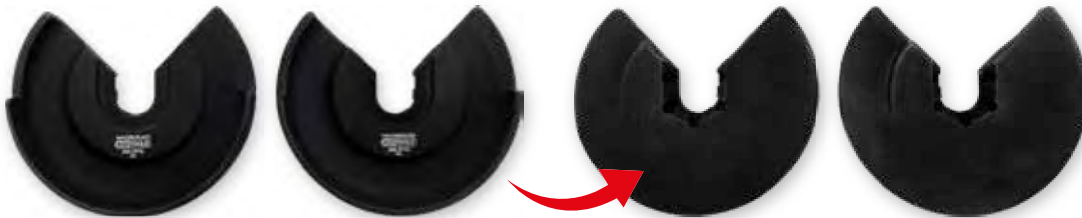

Champ d'application :
Mercedes Classe E (W211 / W212), classe C (W204), GLA (X156), GLK (X204),
Ford Focus II (MK2), BMW 1er (E81), Volkswagen Passat (B8 / 3G)

150,00



500.8770 Jeu de coupelles Ø 95 - 110 mm

POUR UNE EXTENSION



9

Plus d'informations



Ø 30 mm



Ø 90 - 140 mm

Ø 75 - 115 mm

509,00

500.8755 Coffret de compresseurs de ressorts hélicoïdaux



POUR 95 % DES VÉHICULES



Plus d'informations



max
12000
N

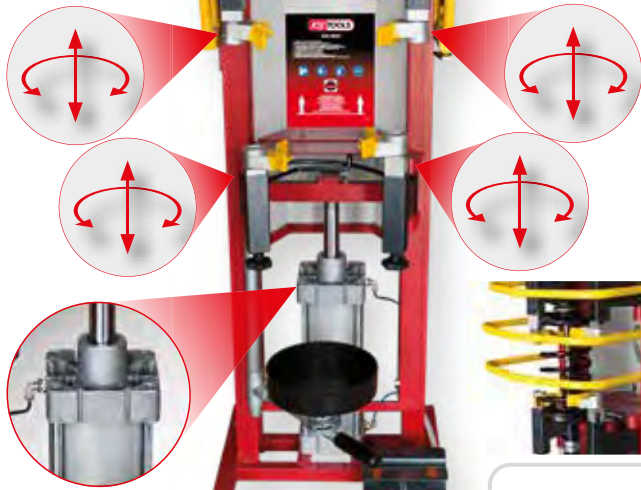

1724,00

Station fixe de compression de ressort d'amortisseur, max. 10 bar

500.8800



Plus d'informations



max
24000
N

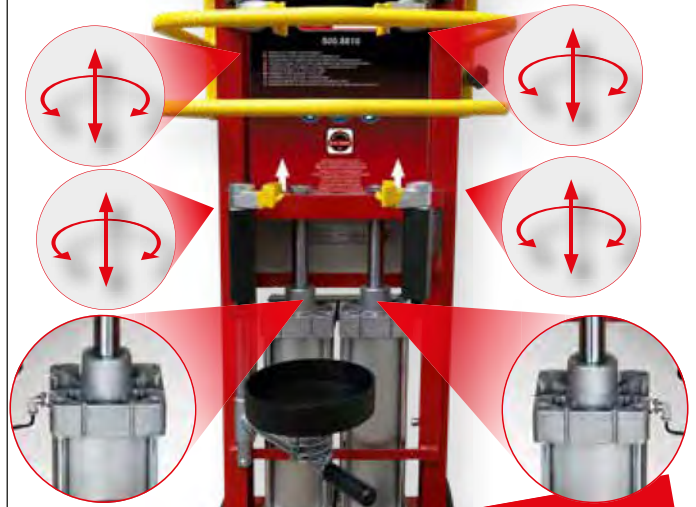

avec doubles cylindres

2399,00

Compresseur de ressort à air comprimé avec doubles cylindres

500.8810



Plus d'informations

- Utilisation facile
- En acier spécial
- Pour fixer les suspensions
- Optimal pour une bonne stabilité
- Avec 4 tiges de fixations et 4 tiges filetées
- Livré avec 2 circlips pour le montage

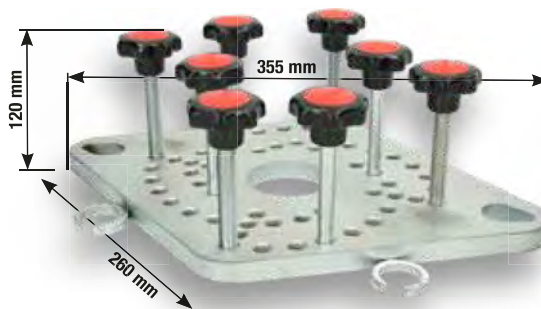

423,00



500.8801 Adaptateur pour coupelles supérieures

JEU DE COMPRESSEURS DE RESSORT AVEC PLAQUE D'ADAPTATION



Plus d'informations



Station fixe de compression de ressort d'amortisseur incl. adaptateur

2024,00

500.8805



Plus d'informations



Compresseur de ressort pneumatique fixe à double cylindre, adaptateur inclus

2699,00

500.8815

CONFIGURATION AU GRÉ DE VOS ENVIES

440.9051



1800,00

568 mm
XL
1429 mm

PLUS
GRAND
QU'IL N'Y
PARAÎT

FREIN

TLG
51

440.9087



3750,00

SLIENT BLOC

TLG
87

440.9025

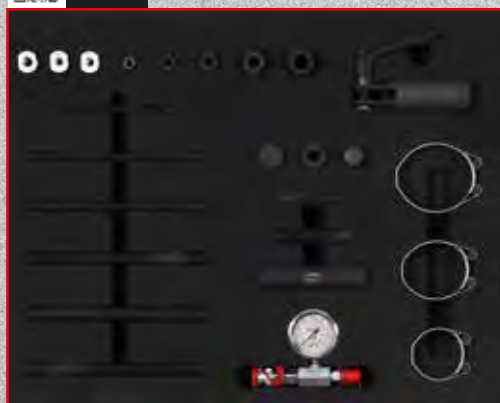

**VÉRIN HYDRAULIQUE SANS
OUTILS D'ACTIONNEMENT**

440.9161



5100,00

PALIER DE ROUE COMPACT

TLG
61

440.9026

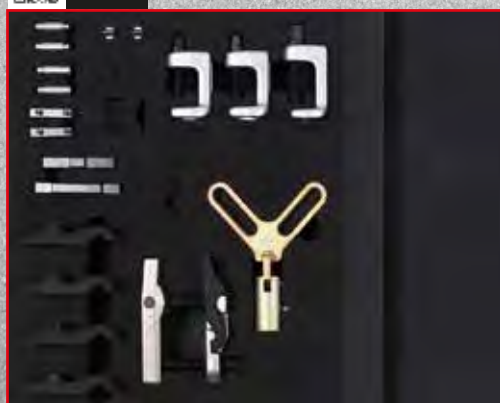

AXE



SIMPLIFIE LA VIE *MODULO 2*



P40

**EDELSTAHL
ROSTFREI**

www.kstools.com

KS TOOLS

Ø 155 mm

1.701 mm

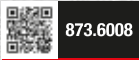

873.6008

**PERFORMANCEplus P40 Chariot
d'atelier NOIR/ROUGE avec 4 tiroirs**

SANS OUTILS

4141,00

Plus d'informations

2200 mm

1350,00

440.9004 Jeu de pompes hydrauliques avec rangement pour P40

1500,00



440.9076



PALIER DE ROUE



1200,00



440.9061



AMORTISSEUR



2850,00

i 1
Plus d'informations

150,00

max. 8 bar

450 mm

1/4" PT

Pour soufflets universels

515.3100 **Expandeur pneumatique de soufflet de cardan**

i 1
Plus d'informations

100 mm

Ø 30 mm

255 mm

75,00

150.1850 **Extracteur de cardans universel**

i 1
Plus d'informations

VA FE

0 - 45 mm

270 mm

60,00

115.1056 **Pince à collier avec embout pour clé dynamométrique**

i 1
Plus d'informations

max. 12 mm

75,00

115.1590 **Pince de serrage pour serre-câbles en acier à billes**

à partir de 39,00

Cooliers serre-câble en acier avec fermeture à bille

200 - 350 mm

115.1591		100	4,6 × 200 mm	39,00 CHF
115.1592		100	4,6 × 250 mm	39,00 CHF
115.1593		100	4,6 × 350 mm	44,00 CHF
115.1594		100	4,6 × 500 mm	57,00 CHF

i 1
Plus d'informations

10 mm

UNIVERSAL

60,00

700.5662 **Outil d'écartement des alésages de serrage**

i **1**
Plus d'informations

38,00

Douille de bras de suspension spéciale Mercedes

150.1721 Mercedes W167, W205, W213, W238, W253, W25

i **6**
Plus d'informations

555,00

Kit Burin pneumatique Vibro-Impact

515.3880

- 110 mm
- 110 mm
- 130 mm
- 100 x 25 x 12 mm

10 mm

10 mm

10 mm

10 mm

31 x 1 sec.

VIBRO-POWER 515.3881

152880316

VIPRO

i **3**
Plus d'informations

48,00

Jeu de chasses pour vis de blocage

700.5635

10 mm

i **1**
Plus d'informations

240,00

Outil pour barres stabilisatrices Vibro-power

150.1608

- Pour desserrer grâce aux vibrations les barres stabilisatrices, les biellettes et les rotules de directions, les contres-écrous...
- Grâce au mandrin vibrant spécial, une impulsion de frappe est donnée sur le vissage à desserrer, ce qui permet de détacher la rouille et de faciliter le processus de desserrage
- Pour mandrin 10 mm

27 mm

290 mm

10 mm

65 mm



Plus d'informations



700.1495 Levier d'essieu universel avec chaîne



- Des courroies flexibles permettent de presser de manière sûre et sans grande utilisation de force, des barres transversales de formes de fabrication les plus diverses



Plus d'informations

183,00

- Filetage trapézoïdale
- Pédale pour un ajustement précis (20 mm)
- Une aide d'atelier précieuse dans beaucoup de situations



160.0342 Etai télescopique à pédale



Plus d'informations



911.8187 Pincès levier de montage articulé télescopique



Plus d'informations

150,00



700.1465 Levier de test de jeu des essieux

i  **6**
Plus d'informations

AVEC VERROUILLAGE RAPIDE 



678,00

1000 W

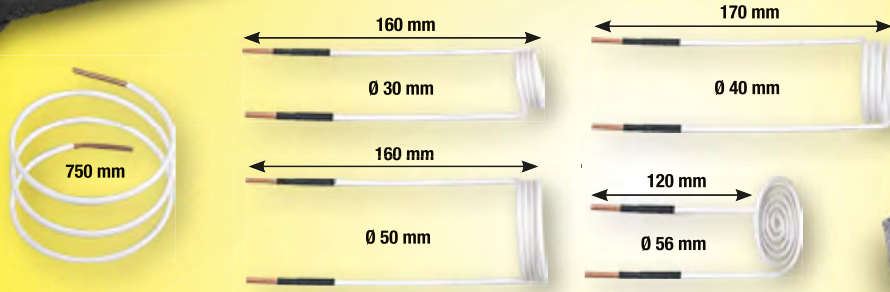

500.8605 Set de pistolets à chaleur par induction



EN OPTION À RACHETER

195,00

500.8440

2E GÉNÉRATION - 2E GÉNÉRATION - 2E GÉNÉRATION

i  **1**
Plus d'informations

NOUVEAU **23,00**

ON S'ACCROCHE !

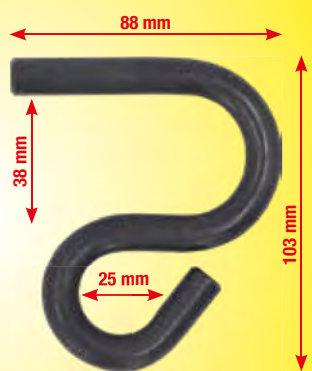
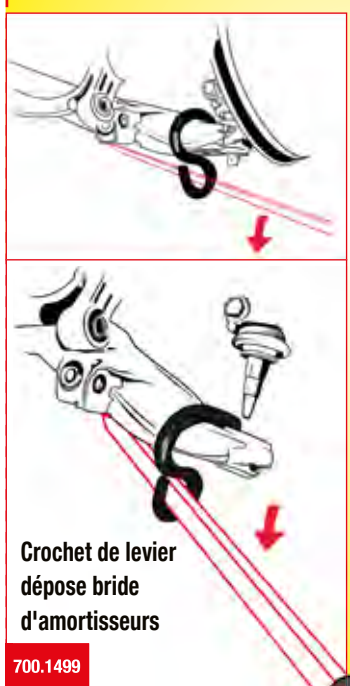

La forme spécifique permet un positionnement très proche de la rotule de suspension

Lever spécial pour un montage ménageant et selon les règles de l'art, sans démontage des pièces des essieux

Crochet de levier dépose bride d'amortisseurs

700.1499

i  **37**
Plus d'informations

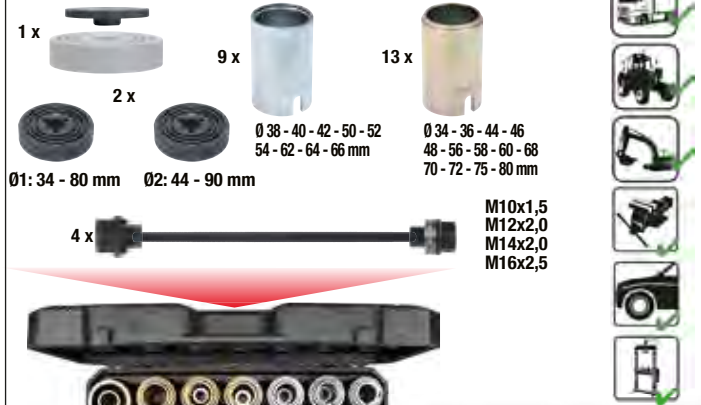

450,00

700.1550 Coffret d'outils pour le montage et le démontage des roulements, joints et bagues



i **22**
Plus d'informations

42 40 38 36 34
32 30 28 26 24
#1
#2
#3
#4

M12
M10
M12 M10 TR20

750,00

700.2355

Jeu de douilles de pression étagées



i **4**
Plus d'informations

120,00

30-35 mm 35-40 mm 40-45 mm

360 mm

1/2" / 32 mm

150.1125

Jeux de clés pour rotules axiales



i **2**
Plus d'informations

M12

NOUVEAU

115 mm
72 mm

30,00

Assortiment de douilles à chocs XZN®

515.0595 1/2"

i **30**
Plus d'informations

1 x $\varnothing 90 - 130$ mm

1 x

4 x M14

4 x M12 x 1,25
M12 x 1,5

4 x M12 x 1,25
M12 x 1,5
M14 x 1,5

1 x M18 x 2,5 x 230 mm

M57 x 2

4,3 Kg

338,00

700.1530

Jeu d'extracteurs universels de moyeux de roues et d'arbres à cardan

MOINS DE PERSONNEL, PLUS DE BÉNÉFICES.

DÉMONTÉ DES PARE-BRISE SANS AIDE !

140.2630

Démonte Pare-brises

- Idéal pour le démontage professionnel et sans dégâts des pare-brises et autres vitres collées
- Livré avec rouleaux-guide pour un travail plus facile et moins de risque de casse du fil
- Le fil est guidé très près de la vitre, cela évite le démontage des garnitures
- Utilisation facile à une personne
- Ventouse de haute qualité pour un maintien sûr



ONE MAN CUT

Jeu de plaques de protection professionnelles, 4 pcs

2x 270x200 mm + 2x 450x300 mm

NOUVEAU



Nylon, 50 m

Poulie de renvoi

Ventouse Ø 50 mm

Ventouse Ø 50 mm

Fixation du fil de coupe

Puissance d'aspiration : 110 kg

Fil carré, 50 m

Levier de décharge

Puissance d'aspiration : 110 kg

Ventouse Ø 150 mm

Fixation du fil de coupe

Aspirateur à pompe haut de gamme

Entraînement 6 pans, 30 mm

Puissance d'aspiration : 110 kg

Sonde d'introduction de fil de découpe, 290 mm

Poulie de renvoi

Puissance d'aspiration : 110 kg

Plaque de protection à bord droit légèrement courbé

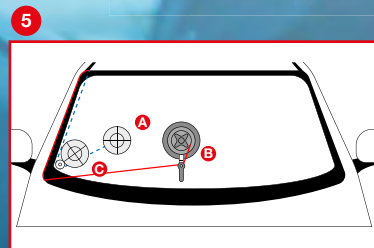
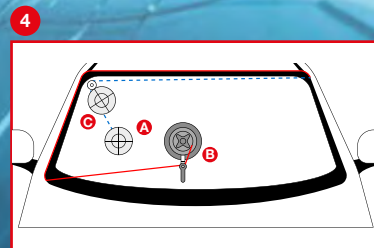
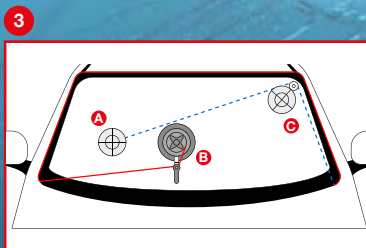
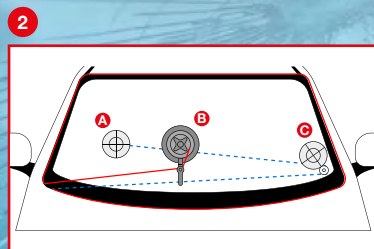
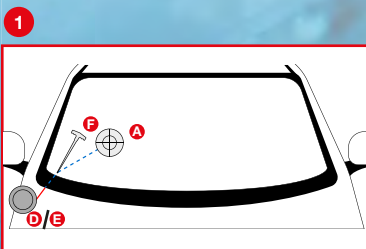

900,00

Y compris



NOUVEAU

1
Plus d'informations

ÉGALEMENT POUR DOT5.1, ENV4 ET ENV6

- Dot3 ✓
- Dot4 ✓

0 20 mm

155 mm **23,00**

Testeur de liquide de frein pour DOT et ENV

150.1969

1
Plus d'informations

VITON®
EKM

42,00

Spray pour les nettoyants de freins

Spécialement destiné au nettoyant de freins

150.8258

2
Plus d'informations

17,00

Kit universel de crochets, formables

150.1935

2
Plus d'informations

23,00

Jeu de deux crochets rigides

150.2235

12
Plus d'informations

75,00

Jeu de douilles pour étriers de freins

150.2400

1/2" 11,5 mm 14 mm 15 mm 20 mm AS 22 mm

1/4" 9 x 20 mm

3/8" 7 x 72 mm
7 x 92 mm
9 x 50 mm
11 x 100 mm

3/8" 7 x 25 - 8 x 25 mm

41
Plus d'informations

150,00

Jeu de repousses piston de frein

150.1970



Plus d'informations

LE GÉNIE UNIVERSEL



UNIVERSAL
Pour 95% des véhicules

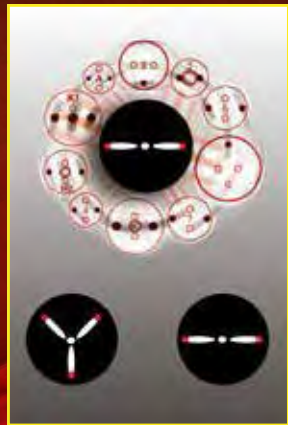

195,00



150.2440 Jeu de repousses-piston de frein universel



Plus d'informations

1050,00



160.0700 Purgeur de liquide frein KS5



Plus d'informations

75,00



160.0718 Adaptateur universel de manchon de purge, réglable

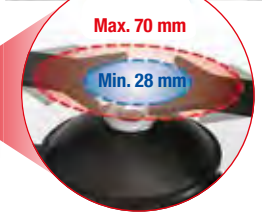

Plus d'informations

TOYOTA & LEXUS



160.0719 Adaptateur universel de manchon de purge pour Toyota et Lexus

26,00

i  **6**
Plus d'informations



1,200 mm

105,00

11 mm
10 mm
9 mm
8 mm
7 mm

160.0725 Jeu de clés de purge de frein



i  **11**
Plus d'informations

LE COMPLET



1,200 mm

STOP

9x12 mm

180 mm

11 mm
10 mm
11 mm
7 mm
11 mm
60 mm
70 mm
75 mm
11 mm
85 mm

113,00

NOUVEAU

518.0320 Jeu de clés de purge de frein por VAG

i  **1**
Plus d'informations



4,75 mm (3/16")

21 mm
31 mm
41 mm
61 mm
76 mm

60,00

120.1006 Outil de cintrage pour circuit de frein

i  **1**
Plus d'informations



4,75 mm (3/16")
6,35 mm (1/4")

45,00

120.1004 Outil de dressage / cintrage pour circuits de frein

- Pliage**
- Duplication**
- Redressement**

OUT IN

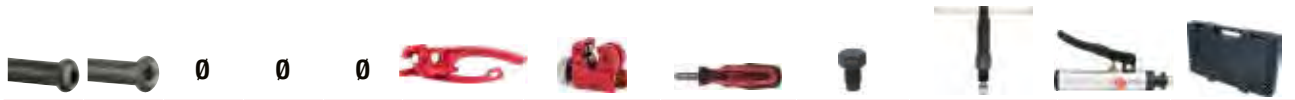

		DIN	SAE	4,75 mm	5,0 mm	6,0 mm	Avec cintreuse	Avec coupe-tube	Avec ébavureur de tube	mécanique	Avec broche hydraulique	Pompe manuelle	Dans le coffret
1	122.1215	✓	✗	✓	✗	✗	✗	✗	✗	✓	✗	✗	✗
2	122.1290	✓	✓	✓	✓	✓	✓	✓	✓	✗	✓	✗	✓
3	122.1260	✓	✓	✓	✓	✓	✗	✗	✗	✗	✗	✓	✓

Plus d'informations

4

75,00

4,75 mm

Special Punch Grease

1 Appareil a collets battu universel
FLAREFIXeco pour durite de frein 4,75 mm

122.1215

Plus d'informations

16

FLAREFIX

255,00

4,75-5,0 mm, SAE

6,0 mm, SAE

4,75-5,0-6,0 mm, SAE-90°

4,75-5,0 mm, DIN

6,0 mm, DIN

M12x1,25

3,0-12,0 mm

3,0-16,0 mm

4,75 mm, 3/16"

5,0 mm

6,0 mm

2 Appareil à collets pour conduites de frein avec
vérin hydraulique FLAREFIX 1

122.1290

Plus d'informations

11

HYDRAULIQUE, PRATIQUE, FANTASTIQUE !

450,00

M12 x 1,25 mm

4,75-5,0 mm, SAE

6,0 mm, SAE

4,75-5,0-6,0 mm, SAE-90°

4,75-5,0 mm, DIN

6,0 mm, DIN

M12x1,25

4,75 mm, 3/16"

5,0 mm

6,0 mm

3 FLAREFIX 2 Appareil à collets pour conduites de frein avec vérin hydraulique

122.1260



Plus d'informations



3/8"



38,00

Kit de profilés spéciaux 3/8" de service à huile pour les vis en plastique d'évacuation de l'huile, 9 pcs

150.1040



Plus d'informations



105,00

- Outil pour rectifier le plan de joint de la vis de carter d'huile
- Rectification parfaite du plan de joint du bouchon de carter d'huile
- Centrage exacte et alignement précis du plan de joint
- Coffret incluant le nécessaire pour le bouchon de vidange d'origine et rectifié
- Coffret robuste en matière plastique



0° / Ø 22

M14x1,5

M15x1,5



150.1485 Jeu de fraises à surfaçer pour socle d'étanchéité de bouchons de vidange



Plus d'informations



7,5 litres

Ø 385 mm

20,00



150.9359 Bac de récupération 7,5 litres

i  **30**
Plus d'informations

1/2" 21 mm
Ø 63 - 102 mm

150,00

3/8" Jeu de cloches filtre à huile

65-14, 65/67-14, 66-6, 68-14, 73-14, 74-15, 74/76-15, 75/77-15, 76-8, 76-12, 76-14, 76-30, 78-15, 80-15, 80/82-15, 86-18, 86-16, 90-15, 92-10, 93-15, 93-36, 93-45, 95-15, 96-18, 100-15, 106-15, 108-15, 108-18



i  **24**
Plus d'informations

2,0 L

150,00

MASTER Jeu d'entonnoirs de remplissage d'huile avec raccord pivotant

VW Lexus Lotus Ford Nissan
Subaru Mitsubishi Land Rover Hyundai Audi
Chrysler Toyota Citroën Volvo Cadillac
Citroën Buick Volvo Buick universel



i  **4**
Plus d'informations

POUR VAG

Avec bras pivotant pour atteindre les endroits difficiles d'accès

23,00

Jeu d'entonnoirs de remplissage d'huile avec raccord pivotant pour VAG



SUR LE PONT ET C'EST PARTI !

En caoutchouc plein

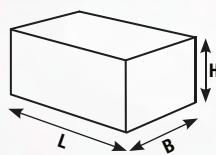

Pièce	L mm	B mm	H mm		
160.0476	1	160	120	20	8, ⁰⁰ CHF
160.0477	1	160	120	30	11, ⁰⁰ CHF
160.0478	1	160	120	40	14, ⁰⁰ CHF
160.0479	1	160	120	60	20, ⁰⁰ CHF
160.0480	1	160	120	80	26, ⁰⁰ CHF
160.0481	1	160	120	100	32, ⁰⁰ CHF
160.0482	1	160	120	115	36, ⁰⁰ CHF
160.0483	1	116.5	116,5	36,5	9, ⁰⁰ CHF
160.0499	1	160	120	85	27, ⁰⁰ CHF

NOUVEAU



PE (Polyéthylène)

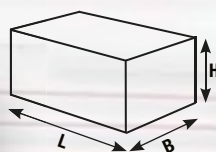

Pièce	L mm	B mm	H mm		
160.0437	1	250	150	55	23, ⁰⁰ CHF
160.0438	1	250	150	100	41, ⁰⁰ CHF
160.0486	1	340	150	55	30, ⁰⁰ CHF
160.0489	1	340	130	100	48, ⁰⁰ CHF

NOUVEAU



Tout en caoutchouc avec un noyau durci

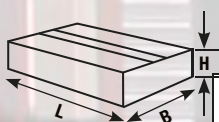

Pièce	L mm	B mm	H mm		
160.0484	1	373	100	35	60, ⁰⁰ CHF

NOUVEAU



En plastique très résistant



NOUVEAU

Model 3 ✓
Model S ✓
Model X ✓
Model Y ✓



160.0460 Tesla Model 3, S, X, Y

36,⁰⁰



En caoutchouc plein

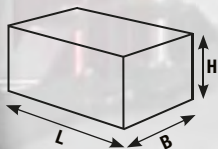

Pièce	L mm	B mm	H mm		
160.0391-TD	4	155	125	35	53, ⁰⁰ CHF



En caoutchouc plein



NOUVEAU

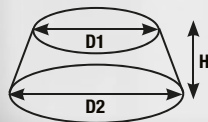

Pièce	D1 mm	D2 mm	H mm		
160.0485	1	78	105	60	15, ⁰⁰ CHF



En caoutchouc et en plaque d'acier

Plus d'informations

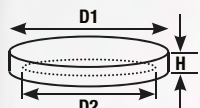

ACIER



	D1 mm	D2 mm	H mm	Ravaglioli	Grazia	OMCN	Intertech	MAHA	Werther	Nussbaum	AMI	Twin Busch	Sirio	Space	Launch	RP Tools	J.A. Becker	ATH	HOFMANN	Hermann		
A	160.0463	120	113	22				✓														14,00 CHF
B	160.0465	123	108	25	✓				✓													14,00 CHF
C	160.0475	120	110	19													✓	✓	✓	✓		14,00 CHF



En caoutchouc

Plus d'informations

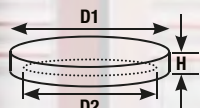

CAOUTCHOUC



	D1 mm	D2 mm	H mm	Ravaglioli	Grazia	OMCN	Intertech	MAHA	Werther	Nussbaum	AMI	Twin Busch	Sirio	Space	Launch	RP Tools	J.A. Becker	ATH	HOFMANN	Hermann		
A	160.0466	125	120	24						✓	✓											18,00 CHF
B	160.0467	140	130	25								✓										9,00 CHF
C	160.0468	100	85	14	✓								✓	✓								8,00 CHF
D	160.0464	120	113	23				✓														8,00 CHF
E	160.0469	120	108	32								✓			✓	✓						12,00 CHF
F	160.0470	130	125	14	✓								✓	✓								8,00 CHF
G	160.0471	140	125	30								✓										12,00 CHF
H	160.0472	150	130	23	✓								✓	✓								11,00 CHF
I	160.0473	120	105	30								✓										11,00 CHF
J	160.0474	120	110	19													✓	✓	✓	✓		8,00 CHF
K	160.0490	100	80	21	✓													✓	✓	✓	✓	6,00 CHF
L	160.0491	120	108	26	✓	✓																8,00 CHF
M	160.0492	120	110	26	✓	✓																8,00 CHF
N	160.0493	145	108	24	✓		✓															12,00 CHF
O	160.0494	145	135	26	✓																	11,00 CHF
P	160.0495	160	135	28			✓															11,00 CHF
Q	160.0496	140	103	25						✓												12,00 CHF
R	160.0497	150	127	25	✓																	9,00 CHF
S	160.0498	140	132	28																		14,00 CHF

i  **1**
Plus d'informations



12,00

**Bol magnétique, biaisé,
Ø 150 mm**

800.0156



i  **1**
Plus d'informations



330 mm

15,00

Tire-valves métallique, 330 mm

150.2032



i  **1**
Plus d'informations

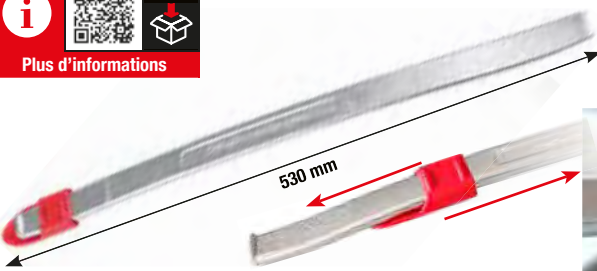

530 mm

42,00

Lever de montage et pneus RunFlat

911.8135



i  **1**
Plus d'informations



75,00

Support magnétique, 390 mm

800.0190



i  **1**
Plus d'informations



600 mm

0 - 12 bar

30,00

Gonfleur d'air

515.1950

1/4" PT



i  **1**
Plus d'informations

ÉTALONNÉ



400 mm

0 - 10 bar

93,00

**Gonfleur d'air
étalonné**

515.1960

1/4" PT



i  **5**
Plus d'informations



60 x 100 mm

70 g

9 mm

86,00

Jeu de vulcanisation de pneus pour véhicules, avec mèches de 100 mm

150.1070

EN OPTION À RACHETER
60 pièces
27,00

150.1072









i  **1**
Plus d'informations

135,00

Jeu de disques à ponner en aluminium pour moyeux Ø 150 mm, Ø intérieur 90 mm

100.5080

EN OPTION À RACHETER

53,00

100.5077

90 mm

150 mm

AVANT :

APRÈS :

i  **4**
Plus d'informations

8 mm

10 mm

8 mm

8 mm

NOUVEAU

Jeu de douilles tournevis-OZ pour jantes aluminium

515.0795  

23,00

i  **3**
Plus d'informations

60,00

1/2" Jeu de douilles double à chocs, 3 pcs, 17 - 21 mm

913.1270   17 - 19 - 21 mm

i  **2**
Plus d'informations

19,5 mm

18,5 mm

19,5

21,5

20,5

20,5 mm

21,5 mm

+

Jeu de douilles à chocs spéciales pour jantes aluminium, pour Ford, 18,5 / 19,5 / 20,5 / 21,5 mm

515.0895   18,5 - 19,5 - 20,5 - 21,5 mm

42,00

i  **1**
Plus d'informations

POUR MERCEDES

max. 75 Nm

27,00

1/2" Rallonges à torsion, 75 Nm

515.1491 



Plus d'informations



Coffret de démontage d'écrous anti-vol

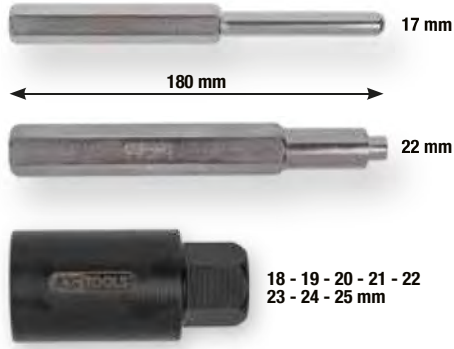

90,00

913.1480 18 - 19 - 20 - 21 - 22 - 23 - 24 - 25 mm



Plus d'informations

Set pour démontage d'écrous antivol



Avec protection des mains



210,00



GÉNIAUX ET UNIVERSELS : ILS S'ADAPTENT À TOUS LES PROFILS !



913.1430

JEUX DE DOUILLES À CHOC 1/2" ROBUSTES POUR JANTES EN ALUMINIUM

1

Plus d'informations

21 mm 19 mm 17 mm

27,00

515.1070 1/2" 17 - 19 - 21 mm

2

Plus d'informations

15 mm 17 mm 19 mm 21 mm 22 mm

38,00

515.0870 1/2" 15 - 17 - 19 - 21 - 22 mm

3

Plus d'informations

105,00

17 mm 15 mm 19 mm 22 mm 23 mm 21 mm 17 mm 21 mm 24 mm

1/2" 15 - 17 - 19 - 21 - 22 - 23 - 24 mm

7/8" 17 mm MS21

515.0890

4

Plus d'informations

15 mm 17 mm 19 mm 21 mm 22 mm 23 mm 24 mm 17 mm 21 mm

210,00

UN OUTIL POLYVALENT

515.0885 1/2" 15 - 17 - 19 - 21 - 22 - 23 - 24 mm 7/8" 17 mm MS21 17 - 19 - 21 mm 18,5 / 19,5 - 20,5 / 21,5 - 17,5 / 22,5 mm

	515.1072 15 mm	515.1073 17 mm	515.1075 19 mm	515.1076 21 mm	515.1077 22 mm	515.1078 23 mm	515.1079 24 mm	515.1089 Tesla 7/8"	515.2055 Mercedes 17 mm	515.2060 Hyundai KIA MS21	913.1271 Douilles spéciales écrous et vis adhésifs 17 mm	913.1272 Douilles spéciales écrous et vis adhésifs 19 mm	913.1273 Douilles spéciales écrous et vis adhésifs 21 mm	515.0896 Ford 18,5 / 19,5 mm	515.0897 Ford 20,5 / 21,5 mm	515.0899 Ford 17,5 / 22,5 mm	515.1134 Rallonges à chocs, 75mm
1	X	✓	✓	✓	X	X	X	X	X	X	X	X	X	X	X	X	X
2	✓	✓	✓	✓	✓	X	X	X	X	X	X	X	X	X	X	X	X
3	✓	✓	✓	✓	✓	✓	✓	✓	✓	✓	X	X	X	X	X	X	X
4	✓	✓	✓	✓	✓	✓	✓	✓	✓	✓	✓	✓	✓	✓	✓	✓	✓

i **1**
Plus d'informations

Rechargeable par câble USB-C (inclus)

26,00

350 Lumens

UV LED

POWER-AAA Li-Ion 800mAh

165 mm

KSTOOLS 150.4400

Avec pointeur laser

Lampe d'inspection à bande LED COB de 350 lumens avec spot UV à LED et pointeur laser

150.4400

i **1**
Plus d'informations

23,00

85 Lumens

2 x AA

140 mm

perfectLight 85 lumens

25 m

Lampe de poche perfectLight 85 lumens

150.4370

i **1**
Plus d'informations

MAX. 350 Lumens

MAX. 100 Lumens

270°

**LE MUST HAVE !
POUR L'ATELIER OU L'EXTÉRIEUR**

23,00

150.4520

Li-Ion 3,7 V 1200 mAh

On/Off

Interruteur à détection

Power Display

Détecteur de mouvement

XPE LED 2 niveaux d'éclairage

COB LED 3 niveaux d'éclairage

Réglage de la taille

95 g

max 8 h

4,5 h

max 10 h

IPX3

AA

Modi	COB 100%	COB 40%	COB rot	XPE 100%	XPE 40%
LED	270° 3 Watt COB LED			1 Watt High Power XPE LED	
40%	350 LM	150 LM	-	100 LM	40 LM
	3 h	6 h	8 h	4 h	8 h

1
Plus d'informations

27,00

250 Lumens

500 Lumens

360°

180°

ON OFF

USB

Batterie lithium-ion de 1 200 mAh (incluse)

ou

3 piles AAA (non incluses)

Fonction USB Power Bank incluse

20 %	●
40 %	●●
60 %	●●●
80 %	●●●●
100 %	●●●●●

150.4510

max. 3 h

3 h

+

IP65

1
Plus d'informations

30,00

130 Lumens

300 Lumens

ON OFF

USB-A OUT

USB-C IN

Batterie lithium-ion intégrée 1.200 mAh

20 %	●
40 %	●●
60 %	●●●
80 %	●●●●
100 %	●●●●●

150.4505

max. 3 h

3 h

+

IP65

1
Plus d'informations

25,00

60 Lumens

150 Lumens

360°

180°

ON OFF

Micro USB

20 %	●
40 %	●●
60 %	●●●
80 %	●●●●
100 %	●●●●●

150.4495

max. 3,5 h

2,5 h

IP20

1
Plus d'informations

57,00

250 Lumens

550 Lumens

ON OFF

USB-A OUT

USB-C IN

Batterie lithium-ion intégrée 1.200 mAh

20 %	●
40 %	●●
60 %	●●●
80 %	●●●●
100 %	●●●●●

150.4490

max. 3,5 h

3 h

+

IP65

i  **11**
Plus d'informations



20-200 Nm

1/2"

500 mm

125 mm

10 mm 13 mm 17 mm 19 mm 21 mm 24 mm

17 mm 19 mm 21 mm

180,00

516.2400 1/2" 10 - 13 - 17 - 19 - 21 - 24 mm

DIN EN ISO 6799
Certificat
Précision $\pm 1,3\%$

KALIBER-KONFORMITÄTSERKLÄRUNG

516.2400

i  **8**
Plus d'informations

POUR UN CHANGEMENT DE PNEUS EN UN TEMPS RECORD

21 mm **19 mm** **17 mm**

1/2"

1600 Nm

2 x

Ø 150 mm

0 - 12 bar

10 m

NOUVEAU

180,00

515.2100

THE DEVIL

ROBOTIT

Votre partenaire

 **4 042146 956601**

LL23-06FR_CHF

KS Tools Werkzeuge - Maschinen GmbH
Seligenstädter Grund 10 - 12
D-63150 Heusenstamm
ALLEMAGNE

Mail: aftersales@kstools.com
Web: www.kstools.com

Suite à la publication du prospectus actuel, les anciens prix perdent leur validité. Nous ne vendons qu'aux distributeurs. Erreurs d'impression, erratum et modifications techniques. Tous les prix en CHF, hors TVA, sont valables jusqu'au 30/09/2024.